

## **Chapter 1. Introduction**

The Joint Global Ocean Flux Study (JGOFS) is an international and multi-disciplinary study with the goal of understanding the role of the oceans in global carbon and nutrient cycles. The Scientific Council on Ocean Research describes this goal for the international program: "To determine and understand the time-varying fluxes of carbon and associated biogenic elements in the ocean, and to evaluate the related exchanges with the atmosphere, sea floor and continental boundaries." As part of this effort in the United States, the National Science Foundation funded two time-series stations, one in Bermuda and the second in Hawaii. The Bermuda Time-series is administered by the Bermuda Biological Station for Research, Inc. (BBSR). Dr. Anthony H. Knap, Director of BBSR, is the principal investigator. Dr. Anthony F. Michaels joined the program in September, 1989 and has been co-principal investigator since 1993. Co-ordination of BATS activities was undertaken by Dr. Dennis Hansell from September 1992 - December 1993, and from July 1995 to date by Dr. Deborah Steinberg.

The objectives of the U.S. JGOFS-sponsored Bermuda Atlantic Time-series Study (BATS) are: (1) to observe and interpret the annual and interannual variability in the biology and chemistry of the mixed layer and euphotic zone, (2) to observe and interpret the annual and interannual variability in the rates of particle flux and the apparent rates of particle remineralization over the entire water column, (3) to understand the interrelationships between the biological and chemical processes involved in (1) and (2) above and the physical characteristics of the water column and (4) to provide data on global trends of selected oceanic properties over decadal time scales.

Data collection for the Bermuda Atlantic Time-series Study began in October, 1988, with a gradual phase-in of the current set of measurements over a two to three month period. This manual describes the methods for the suite of measurements being routinely made during the ninth year of sampling. Also included are methods for hand nutrients (Chapters 9 -12), for use when an AutoAnalyser is not available. Reports of data collected over twelve month periods are available up to BATS 72 (September 1994). From BATS 73 onwards, five-year data reports will be produced. These data reports also include updates on methods if they are altered or if new measurements are added. Data can be accessed via the World Wide Web, through the homepage of the Bermuda Biological Station (URL - <http://www.bbsr.edu>) using a link to a data extraction program (URL- <http://www.bbsr.edu/~ctd>). The digital data are available on an anonymous ftp account or can be requested from BBSR (rod@bbsr.edu or bahr@bbsr.edu). The appropriate ftp account is ftp.bbsr.edu (198.116.90.3). The user should Log in as anonymous and use his/her own account name as the password. The BATS data are in pub/BBSR/BATS, with each BATS

year after that. The data are also available through NODC (Woods Hole Oceanographic Institution), and are presently being integrated into the JGOFS Data Management System, information for which can be obtained from Christine Hammond at WHOI (chammond@whoi.edu).

The time-series program as it developed was the joint effort of a number of people from different institutions. Early on, Dr. Paul Wassman provided scientific assistance in the first months. The primary production and sinking flux measurements were developed and carried out under a subcontract to Drs. George A. Knauer, Steve E. Lohrenz and Vernon A. Asper at the Center for Marine Science at the University of Southern Mississippi, until February 1991. Merritt Tuel (USM) participated on nearly every cruise during this period to perform these measurements. Samples were also collected and dispersed to Dr. Hugh Ducklow (Horn Point Ecological Laboratories) for enumeration of bacteria by Helen Quinby until February 1991, and to Dr. Peter Brewer (Woods Hole Oceanographic Institution) for the measurement of total carbon dioxide until September 1990. HPLC pigments were analyzed by Dr. Robert Bidigare (currently at the University of Hawaii) from October 1989 - September 1990. Each of these measurements were gradually transferred to BBSR personnel as the program developed. At the date of publication of this manual, all measurements are made in Bermuda at BBSR. BATS personnel who are or who have been involved with the program include:

Frederick Bahr	Sept 93 - present	Frances Howse	April 91- Sept 96
Rhonda Kelly	May 93 - Nov 94	Rodney Johnson	Sept 88 - present
Dr. Nicholas Bates	Jan 91 - present	Sarah Goldthwait	June 96 - present
Susan Becker	Jan 94 - Feb 95	Rebecca Little	Jan 94 - May 96
Steven Bell	June 96 - present	Ru Morrison	July 96 - present
Margaret Best	May 91 - Nov 92	Karen Orcutt	Feb 95 - present
Peter Countway	Feb 95 - May 96	Marta Sanderson	May 96 - present
Elizabeth Caporelli	Sept 93 - Dec 96	Rachael Sherriff-Dow	Sept 88- Nov 94
Matthew Church	May 94 - April 96	Jens Sorensen	April 90 - Nov 93
Ann Close	May 90 - Aug 94	Shannon Stone	Nov 94 - present
Alice Doyle	Jan 92 - June 96	Cathy Rathbun	April 96 - present
Kjell Gundersen	Sept 88 - present	Tye Waterhouse	Jan 93 - Feb 94
Melodie Hammer	June 91 - Sept 93		

This manual represents the fourth iteration of the BATS methods manual. The changing character of the manual reflects the constant efforts to improve the quality of analysis. The first three manuals, dated March 1990, June 1991 and March 1993 are archived and available at BBSR. This fourth revision is available from the U.S. JGOFS Planning Office. Most alterations in methods are minor. Where major changes have occurred, a substantial period of overlap, when both analyses are performed on the same samples, is conducted to verify that both methods give the same result or to document the magnitude of the change in result.

*Bermuda Biological Station For Research, Inc.  
Bermuda Atlantic Time-series Study*

## **Chapter 2. Shipboard Sampling Procedures**

Updated by: R. Johnson and F. Howse (April 1997); R. Little and R. Johnson (April 1996); A. Close (May 1994); A. Michaels (March 1992); A. Michaels (May 1991)  
Prepared by: A. Michaels (March 1991)

### **1.0 Introduction**

The BATS cruises consist of a single four–five day cruise at monthly intervals. The core set of measurements (see table 1 for complete set of measurements) are collected on two hydrocasts with a 24 place rosette, one dawn - dusk *in situ* measurement of integrated primary production and a sediment trap deployment of three days duration. These cruises usually follow a regular schedule for the sequence and timing of events. This schedule is described below. Weather, equipment problems and other activities occasionally cause this schedule to be interrupted or rearranged. In the data report for each cruise, the exact schedule actually used is reported, including the timing and nature of all additional activities. The schedule described below represents a summary of all the core activities on each cruise in the order that they would be performed barring any other factors.

The transit time to the BATS station (31° 40' N, 64° 10' W) is approximately 6 hours. First the sediment traps are deployed at a site 5 nautical miles S of BATS to avoid entanglement with moored arrays in the vicinity of the OFP site (31° 50' N, 64° 10' W). The trap is free-floating and equipped with a strobe, radio beacon and an ARGOS satellite transmitter. Once deployed, the ship returns to the nominal BATS station to commence the sampling. In the first six years of the BATS program (until September 1994, BATS 72) the ship remained near the traps for the sampling period resulting in a quasi-Lagrangian sampling plan. In this time the maximum deviation from the nominal site was approximately 100 km, however, for approximately 75 % of cruises the deviation was less than 25 km.

### **2.0 Hydrocasts**

The core measurements require 2 hydrocasts using a 24 place rosette system. The deeper of the two casts is usually done first. 24 discrete water samples are taken on each cast with 12 liter Ocean Test Equipment® (OTE) bottles.

The cast order is as follows:

**Cast 1:** 0–4200 m. Bottle samples (24) are collected at 100 m intervals from 300 - 1400 m, at 200 m intervals from 1400 - 2600 m, then at 3000 (duplicates), 3400, 3800, 4000 and 4200 m.

**Cast 2:** 0–250 m. Two bottles are closed at each of the following depths: the surface, 10, 20, 40, 60, 80, 100, 120, 140, 160, 200, 250 m.

### 3.0 Water Sampling

Sampling begins immediately after the rosette is brought on board and secured in the CTD garage. Care is taken to protect the rosette sampling operation from rain, wind, smoke or other variables which may effect the samples.

**Cast 1:** Oxygen samples are drawn first from all depths. After all the oxygen samples are drawn, samples for dissolved organic matter are taken (DOC and DON), followed by salinity and nutrient samples. Samples for particulate organic carbon and nitrogen (POC/ PON) and particulate silicate (PSi) are taken from the top 8 depths. Finally, samples for bacterial enumeration are drawn at 3000 and 4000 m.

**Cast 2:** Oxygen samples are drawn from all depths, from one set of OTE bottles. Samples for total CO<sub>2</sub> (C<sub>T</sub>) and alkalinity, dissolved organic matter (DOC and DON), salinity and nutrients are also taken from this one set of bottles.

The replicate depths are used for POC/ PON and PSi samples, followed by samples for fluorometric chlorophyll, HPLC determination of pigments, and bacterial enumeration.

Deckboard water-processing activities are usually divided into specific tasks. Two or three people draw the water, while one person keeps track of the sampling operation. Bottle numbers for each sample at each depth are determined before the cast. All of the people sampling are informed of the sampling scheme and the oversight person ensures that it is carried out accurately.

### 4.0 Primary Production

The primary production cast is generally performed on the second day, depending on the weather, time of arrival at station, etc. The dawn to dusk *in situ* production measurement involves the pre-dawn collection of water samples at the BATS site at 8 depths using trace-metal clean sampling techniques. The bottles are 12 liter Go-Flos with Viton O-rings. These Go-Flos are acid cleaned with 10 % HCl between cruises. The bottles are mounted on the Kevlar line and depths are measured with a metered block, or premeasured before the cast, and marked. These samples are brought back on deck, transferred in the dark to 250 ml incubation flasks, the <sup>14</sup>C spike added and the flasks attached to a length of polypropylene line at each depth of collection. This array is deployed at the BATS site with

surface flotation which includes a radio beacon and a flasher. The ship follows this production array during the 12–15 hour period that it is deployed, occasionally shuttling back to the sediment trap location. This array is recovered at sunset and processed immediately.

## 5.0 Sediment Trap Deployment and Recovery

Upon arrival at the BATS station, the sediment trap array is deployed and allowed to drift free for a 72 hour period. The trap array has Multi-traps at 150, 200, and 300m depths. The array's location is monitored via the ARGOS transponder and by regular relocation by the ship. Twice daily, the trap position is radioed to the ship by BBSR personnel. The traps recovery is generally the last operation carried out before returning to the dock.

## 6.0 Sample Processing

Most of the actual sample analysis for the short BATS cruises is done ashore at the Bermuda Biological Station for Research. Oxygen samples are analyzed at sea because of concerns regarding the storage of these samples for periods of two to three days. Oxygen samples collected on the last day are sometimes returned to shore for analysis. All of the other measurements have preservation techniques that enable the analysis to be postponed. See the individual chapters for details.

The analysis of particulate silicate (PSi) is carried out by Dr. Mark Brzezinski at the University of California at Santa Barbara (UCSB). Analysis of dissolved organic nitrogen (DON) is undertaken by Dr. Dennis Hansell, and measurement of alkalinity by Dr. Nicholas Bates, both at Bermuda Biological Station for Research. The methods used are not detailed in individual chapters here but can be obtained from the references listed below.

## 7.0 References

Hansell, D.A. and T. Y. Waterhouse. (1997). Controls on the distribution of organic carbon and nitrogen in the eastern Pacific Ocean. *Deep-Sea Research* 44: No.5: 843-857.

Brzezinski, M. A. and D. M. Nelson (1995). The annual silica cycle in the Sargasso Sea near Bermuda. *Deep-Sea Research*. I 42: 1215-1237.

D.O.E. (1994). *Handbook of methods for the analysis of the various parameters of the carbon dioxide system in seawater*; version 1.0, edited by A.G. Dickson and C. Goyet.

**Table 1. Core measurements made at the BATS site**

**Continuous Electronic Measurements:**

<u>Parameter</u>	<u>Depth Range (m)</u>	<u>Technique/Instrument</u>
Temperature	0-4200	Thermister on Seabird SBE-911 plus CTD
Salinity	0-4200	Conductivity sensor on SeaBird SBE-911 plus CTD
Depth	0-4200	Digiquartz pressure sensor on SeaBird SBE-911 plus CTD
Dissolved Oxygen	0-4200	SeaBird Polarographic Oxygen Electrode
Beam Attenuation	0-4200	SeaTech, 25 cm Transmissometer
Fluorescence	0-500	SeaTech Fluorometer

**Discrete Measurements from OTE Bottles on CTD:**

<u>Parameter</u>	<u>Depth Range (m)</u>	<u>Technique/Instrument</u>
Salinity	0-4200	Conductivity on Guildline Autosol 8400A
Oxygen	0-4200	Winkler Titration, automated endpoint detection
Total CO <sub>2</sub>	0-250	Automated coulometric analysis
Alkalinity	0-250	High precision titration
Nitrate	0-4200	CFA colorometric with Technicon AA
Nitrite	0-4200	CFA colorometric with Technicon AA
Phosphate	0-4200	CFA colorometric with Technicon AA
Silicate	0-4200	CFA colorometric with Technicon AA
Dissolved organic carbon	0-4200	High-temperature, catalytic oxidation
Dissolved organic nitrogen	0-4200	UV oxidation
Particulate organic carbon	0-4200	High-temperature combustion, CHN analyzer
Particulate organic nitrogen	0-4200	High-temperature combustion, CHN analyzer
Particulate silica	0-4200	Chemical digestion, colorometric analysis
Fluorometric chlorophyll a	0-250	Acetone extraction, Turner fluorometer
Phytoplankton pigments	0-250	HPLC, resolves 19 pigments
Bacteria	0-3000	DAPI stained, fluorescence microscopy

**Rate Measurements:**

<u>Parameter</u>	<u>Depth Range (m)</u>	<u>Technique/Instrument</u>
Primary production	0-140	Trace-metal clean, <i>in situ</i> incubation, <sup>14</sup> C uptake
Bacterial activity	0-140	Thymidine incorporation
Particle fluxes	150, 200, 300	Free-drifting cylindrical trap (MultiPITs)
Mass flux		Gravimetric analysis
Total carbon flux		Manual swimmer removal, CHN analysis
Organic carbon flux		Manual swimmer removal, acidification, CHN analysis
Organic nitrogen flux		Manual swimmer removal, CHN analysis

## **Chapter 3. CTD and Related Measurements**

Updated by: R. Johnson, F. Bahr, and S. Stone (April 1997); R. Johnson (February 1994); A. Michaels and R. Johnson (September 1992)  
Prepared by: A. Michaels and R. Johnson (October 1989)

### **1.0 Scope and field of application**

This chapter describes an appropriate method for a Sea-Bird CTD. The CTD with additional sensors is used to measure continuous profiles of temperature, salinity, dissolved oxygen, beam attenuation and *in vivo* fluorescence.

### **2.0 Apparatus**

The Sea-Bird CTD instrument package is mounted with either a 24 position General Oceanics Model 1016-24 smart rosette or a 24 position Sea-Bird Electronics model 32 rosette, either of which is equipped with 12 l Ocean Test Equipment bottles (O.T.E. bottles).

The basic system used to acquire CTD data is a Sea-Bird SBE-09 *plus* CTD, with an internal Digiquartz pressure sensor, a Sea-Bird SBE-03f temperature sensor, a Sea-Bird SBE-04 conductivity cell and a Sea-Bird SBE-05 pump. Additional sensors include the Sea-Bird SBE-13 dissolved oxygen sensor, the Sea-Tech transmissometer and the Chelsea fluorometer. Present configuration also includes a secondary temperature sensor, conductivity sensor and pump, which are connected independently from the primary units. The temperature and conductivity sensors are connected by a standard Sea-Bird "TC-duct" (clear, low viscous type) which ensures that the same parcel of water is sampled by both sensors, improving the accuracy of the computed salinity. The dissolved oxygen sensor is connected downstream from the conductivity cell and the flow rate through this sensor configuration is maintained at a steady rate by the inertia balanced SBE-05 pump. This pumped flow-through system introduces a slight warming of the water parcel as it passes through the "TC-duct" due to viscous effects (Nordeen Larson, Sea-Bird Electronics, personal communication). The error in measured temperature is greatest in the deep water and is typically less than 0.003°C. A correction for this heating effect will be made available in the near future. The pressure sensor is insulated by standard Sea-Bird methods and consequently has minimal thermal errors in its signal.

- 2.1 *Pressure*: Sea-Bird model 410K-023 digiquartz pressure sensor with 12-bit A/D temperature compensation. Range: 0–7000 dbar. Depth resolution: 0.004% full scale. Response time: 0.001 s.
- 2.2 *Temperature*: SBE 3–02/F. Range: -5 to 35°C. Accuracy:  $\pm 0.003^\circ\text{C}$  over a 6 month period. Resolution: 0.0003°C. Response time: 0.082 s at a drop rate of  $0.5\text{ m sec}^{-1}$ .
- 2.3 *Conductivity*: (flow-through cell): SBE 4-02/0. Range: 0-7 Siemens  $\text{m}^{-1}$ . Accuracy  $\pm 0.003\text{ S m}^{-1}\text{ year}^{-1}$ . Resolution:  $5 \times 10^{-5}\text{ S m}^{-1}$ . Response time: 0.084 s at a  $0.5\text{ m s}^{-1}$  drop rate with the pump.
- 2.4 *Pump*: SBE 5-02. Typical flow rate for the BBSR system is approximately  $15\text{ ml s}^{-1}$ . (The pump is used to control the flow through the conductivity cell to match the response time to the temperature sensor. It is also used to pull water through the dissolved oxygen sensor.)
- 2.5 *Dissolved Oxygen*: (Flow-through cell): SBE 13-02 (Beckman polarographic type) Range: 0-15  $\text{ml l}^{-1}$ . Resolution: 0.01  $\text{ml l}^{-1}$ . Response time: 2 seconds.
- 2.6 *Beam Transmission*: Sea Tech, 25 cm path-length. Light source wavelength = 670 nm. Depth range: 0–5000 m. eighth
- 2.7 *Fluorescence*: Chelsea-MkIII Aquatracka (Chlorophyll *a*) SN 88/2615/132. Sensitivity:  $0.01\text{ }\mu\text{g l}^{-1}$  to  $100\text{ }\mu\text{g l}^{-1}$  with an accuracy of  $\pm 0.01\text{ }\mu\text{g l}^{-1}$ . Excitation: 430 nm peak, 105 nm FWHM. Emission: 685 nm peak, 30 nm FWHM. Depth range: 0-6000 m.

The temperature sensor, conductivity cell and dissolved oxygen sensor are returned to Sea-Bird approximately twice a year for routine calibration. Pumps are returned to Sea-Bird once a year for routine diagnostic checks for RPM accuracy and pump head integrity. The pressure transducer is calibrated every 3 years and it is usual that this calibration is performed during complete CTD maintenance checks or upgrades at Sea-Bird.

### 3.0 Data Collection

The CTD is operated as per Sea-Bird's suggested methods. The CTD is powered up and allowed to stabilize at a depth of approximately 5 meters prior to profiling. This stabilization period is important for both the conductivity and dissolved oxygen sensors which have typical warm up times of one and five minutes respectively. Once stable the CTD is brought back to surface from which point the profile begins. The package is dropped at 30-60 m per minute for the first 200 m and then 45-60 m per minute from 200



meters down. The larger 24 position rosettes are found to give significant eddy wake problems which are most obvious in stratified regions. During high sea states these wakes can result in sections of the water column, as large as 4 m, being contaminated with entrained water. To help alleviate this mechanical problem, the CTD is always dropped at the maximum permitted speed. At present, BBSR is experimenting with mounting the secondary temperature and conductivity sensors away from the rosette package on the exoskeleton type frame. On discussion with Sea-Bird, some data processing steps were suggested to help reduce these bad data. However, at this stage no suitable algorithms other than the accepted velocity and acceleration filters have been developed. Ultimately, we believe this problem needs to be addressed as a package dynamics problem as opposed to a software filter routine. A offset exists between the down- and upcast profiles which is most likely an additional artifact of the package wake. The offset is greatest in the seasonal and permanent thermoclines where differences between the down- and upcast temperatures can be as large as 0.4°C. Since the sensors are mounted below the OTE bottles, we believe the error to be biased in the upcast data (Nordeen Larson, personal communication).

Water samples are collected on the upcast. Prior to closing each OTE bottle, the CTD is kept at the desired depth for a minimum of 90 seconds which ensures that the entrainment from the following wake has been removed. Analysis of the temperature and conductivity data at the time of the OTE bottle closure (following the wait period) shows good agreement with the downcast data. Once the water sample is taken the CTD immediately continues with the upcast at an ascent rate of 60 m per minute.

Except as noted, data are acquired using the Sea-Bird software "Seasoft" at the full scan rate of 24Hz. The data are stored directly on a PC-486. Immediately following the completion of the cast the data are backed up to a Pinnacle Micro PMO-650 magneto optical drive. During each cast a CTD log sheet is filled out (Figure 1). The ship's position is recorded directly from the DGPS. Relevant information such as weather conditions are added in the notes section.

The file naming convention used for BATS CTD data is as follows:

**GF###C@@**

Where:

### is the cruise number (e.g. 108 for the one hundred and eighth BATS cruise)

@@ is the cast number on that cruise (e.g. 04 for the fourth cast)

The Sea-Bird software produces four files for each cast using the above BATS prefix convention. The four files are:

GF###C@@.DAT    Raw 24Hz data file, binary

GF###C@@.HDR	Header file, lat, long, time, etc.
GF###C@@.CON	Configuration file, containing instrument configuration and calibrations used by the software
GF###C@@.BL	Bottle file, a record of time and scan number range (1.5 seconds) when bottle is fired

Sea-Bird data acquisition and processing software are used during the cruise for preliminary observations of raw data. The programs are:

- SEASAVE: Display, recording and playback of data.
- SEACON: Entry of calibration coefficients and recording of the configuration.

## 4.0 Data Processing

Data processing is completed at BBSR and can be divided into two major stages: 1) CTD signal conversion and dynamic sensor correction; 2) static drift corrections and empirical field calibrations.

4.1 *Stage 1: CTD Signal Conversion and Dynamic Sensor Correction.* This stage is performed on an IBM PC using Sea-Bird "Seasoft" software and on a UNIX Sparc station using the Matlab (The Math Works, Inc., 21 Elliot Street South, Natick, MA 01760 USA) environment (see Figure 2 for programs and sequence of operations).

4.1.1 *Preliminary CTD Sensor Quality Check:* First, all CTD cast \*.CON files are checked for correct sensor calibration coefficients using Seacon. The raw 24 Hz data are converted to engineering units using the most recent calibrations; it is then averaged to 2 Hz. Using Matlab the difference between primary and secondary temperature and conductivity sensors and computed salinity are computed for both the upcast and downcast. These differences are plotted and used to check individual sensors for drift, response and other obvious signs of sensor malfunction.

4.1.2 *Determination of Dynamic Coefficients:* The next step in CTD processing is the determination of the coefficients used in the Alignctd and Celltm Seasoft programs. The Alignctd program corrects for the different response times and physical alignment of the CTD sensors so that all sensors are measuring the same parcel of water. Pressure, temperature, conductivity, oxygen current and oxygen temperature data are converted to engineering units for the calibration cast (a single 400m profile without bottle fires) only. For the Alignctd coefficient determination, a series of files are created using Alignctd by vary-

ing the ratio of oxygen signal advancement from 2.0 to 8.0 seconds in 0.5 second increments. Next the parameters potential temperature and oxygen are computed using the Seasoft program Derive. A velocity filter (Loopedit) removes all scans when the CTD is moving less than  $0.3 \text{ m s}^{-1}$ . Finally, using Matlab, the sum, mean and the standard deviation of the difference between the downcast and the upcast oxygen profiles are computed for each file. The time advancement for the oxygen cast with the lowest sum and mean is then applied to all casts.

A similar procedure is used to calculate the coefficients used in Celltm, a program which corrects for thermal mass problems associated with the conductivity cell. Using the calibration cast, a series of files are created by varying alpha, the thermal anomaly amplitude from 0.02 to 0.06 and tau (1/B), the thermal anomaly time constant, from 6.0 to 9.0. Next, using Derive, salinity is calculated for each file and the velocity filter (Loopedit) removes all scans when the CTD is moving less than  $0.3 \text{ m s}^{-1}$ . In Matlab the sum, mean and standard deviation of the difference between the downcast and the upcast salinity are computed for each file. The alpha and tau for the file with the lowest sum and mean difference are later applied to all casts.

- 4.1.3 *Stage 1 Final Processing:* Next the raw data are again converted to engineering units and the values of salinity and oxygen are computed. A 1.5 second average of the data is computed for each bottle fire. All CTD channels and voltage frequencies are converted to engineering units. All primary and secondary channels, plus the oxygen current and oxygen temperature, are run through a 21 point median filter. If a standard resolution pressure sensor is used then it is necessary to smooth the digitized pressure signal by application of a suitable filter. The oxygen channels have a large variance in their signals which is effectively reduced by applying a 21 point Gaussian filter. Additional channels used to measure beam attenuation and in vivo fluorescence are not passed through any filters. The dissolved oxygen is then aligned in time relative to pressure according to the advance in oxygen which best minimized the difference between down- and upcast oxygen in the coefficient determination step described previously. It should be noted that the SBE-11 *plus* deck unit is set to automatically advance primary conductivity 1.75 scans, but secondary conductivity must be advanced using the Alignctd program. The next step is to correct the conductivity cell for its thermal mass using the coefficient which best minimized the difference between down- and upcast salinity in the coefficient determination step described above. Once the dynamic corrections have been applied the salinity and the dissolved oxygen are computed. The data are then passed through a velocity filter. This filter excludes all scans for which either the pressure is not increasing or the descent rate is less than  $0.3 \text{ m s}^{-1}$ . Finally the data are averaged in 2Hz bins.

4.2 *Stage 2: Static Drift Corrections and Empirical Field Calibrations.* This stage of processing is done on a Sun Sparc station using the Matlab programming environment. It involves applying the static drift corrections and any empirical field calibrations to the dynamically corrected 2 Hz data ultimately yielding a final 2 dbar data stream (see Figure 3 for programs and sequence of operations).

4.2.1 *Temperature Corrections:* The Sea-Bird temperature sensors are found to have characteristic drift rates which are linear in time with a small or zero dependency on the temperature (for  $2^{\circ}\text{C} < T < 30^{\circ}\text{C}$ ). For each cruise the calibration history is used to determine monthly drift rates which are applied to the most recent calibrations. The corrected temperature measurement  $T$ , is given by:

$$T = T_u + t(T_s T_u + T_o)$$

Where:

- $T_u$  = uncorrected *in situ* temperature ( $^{\circ}\text{C}$ )
- $t$  = time from most recent calibration (months)
- $T_s$  = slope correction ( $\text{month}^{-1}$ )
- $T_o$  = offset correction ( $^{\circ}\text{C month}^{-1}$ )

4.2.2 *Pressure Corrections:* The Sea-Bird Digiquartz pressure sensor is found to have a characteristic linear drift with time which is typically less than 0.5 dbar per year. The drift is monitored on a 6 monthly basis under stable conditions at the dock. To determine the drift the CTD is allowed to stabilize for a about 3 hours. The drift,  $P_d$  (in dbar), from Seabird calibrations is determined by:

$$P_d = P_s - \frac{(P_a - P_{astd})}{10}$$

Where:

- $P_s$  = stable CTD pressure reading (dbar)
- $P_a$  = atmospheric air pressure (mbar)
- $P_{astd}$  = one standard atmosphere (1013.25 mbar)

4.2.3 *Conductivity Corrections*: The Sea-Bird conductivity sensors are found to have a drift rate which is a linear function of time and conductivity. For each cruise the calibration history is used to determine monthly drift rates which are applied to the most recent calibrations. The corrected conductivity measurement  $C_c$ , is given by:

$$C_c = C_u + t(C_s C_u + C_o)$$

Where:

- $C_u$  = uncorrected *in situ* conductivity ( $S\ m^{-1}$ )
- $t$  = time from most recent calibration (months)
- $C_s$  = slope correction (/ month)
- $C_o$  = offset correction ( $S\ m^{-1}\ month^{-1}$ )

The conductivity cell is calibrated against samples taken from the OTE bottles during the upcast. Typically we have 36 samples ranging from 0-4200m. The discrete samples are measured for salinity on a Guildline 8400A autosal. The conductivity is back calculated from the salinity value and then matched to the corresponding in-situ conductivity reading. A 3s average prior to the OTE bottle closure is used for the in-situ value. These matched pairs from all casts for each particular cruise are grouped together to produce a single equation for the field correction. The deviation between the CTD and bottle value is modelled as a polynomial expression given by:

$$\Delta C = \sum_{i=0}^n a_i C_c^i$$

Where:

- $\Delta C$  = Discrete conductivity - CTD
- $C_c$  = *in situ* conductivity ( $S\ m^{-1}$ )
- $a_i$  = regression coefficients

The corrected continuous CTD conductivity (C) is then given by:

$$C = C_c + \Delta C$$

The order of the polynomial is modified to provide the best fit for the lowest order polynomial. The best fit is determined from the RMS value and a graphical examination of the residuals. The polynomial is usually linear or quadratic. The corrected conductivity and temperature are then used to calculate a calibrated salinity (PSS - 78). The residuals between CTD calculated salinity and bottle salinities are typically less than 0.0015.

- 4.2.4 *Oxygen Corrections*: There are 36 replicate discrete oxygen samples from 0-4200 m. These oxygen samples from the upcast are mapped to the downcast profile at the temperature of the OTE bottle closure. These matched pairs from all associated casts are grouped together to determine a single equation for the complete depth range. The measured bottle oxygen values are regressed against temperature, pressure, oxygen current, oxygen temperature and oxygen saturation such that the CTD oxygen is directly predicted by the following equation:

$$MO = 300 \left( R_0 + \sum_{i=1}^l A_i \left( \frac{P}{4300} \right)^i + \sum_{i=1}^m B_i \left( \frac{OT}{30} \right)^i + \sum_{i=1}^n C_i (OC)^i + \sum_{i=1}^o D_i \left( \frac{OS}{300} \right)^i \right)$$

Where:

$MO$	=	model CTD oxygen
$R_0$	=	linear offset
$P$	=	pressure (dbar)
$OT$	=	oxygen temperature (°C)
$OC$	=	oxygen sensor current (µA)
$OS(T,p,S)$	=	oxygen saturation value at measured temperature, salinity and pressure (µmol kg <sup>-1</sup> )
$A_i, B_i, C_i, D_i$	=	regression coefficients
$l, m, n, o$	=	order of the polynomial functions ( $l, m, n = 2, o = 1$ or $2$ , depending on structure in upper ocean.

The order of each polynomial is determined by comparing successive fits until the correlation coefficients stabilize, and the residuals seem randomly distributed. The standard deviation of the residuals is typically less than 1.5 µmol kg<sup>-1</sup>.

- 4.2.5 *Transmissometer Calibration*. The transmissometer shows frequent offsets in deep water which indicate variations in its performance. The theoretical clear

water minimum beam attenuation coefficient is 0.364 (Bishop, 1986). We assume that the minimum beam 'C' value observed at the BATS site in the depth range 3000-4000 m is representative of a clear water minimum. We equate this minimum value with the theoretical minimum to determine an offset correction. The correction is given by:

$$\text{offset} = 0.364 - \text{BAC}_{\min}$$

where  $\text{BAC}_{\min}$  = minimum beam 'C' for 3000 m < depth < 4000 m. This offset is applied to the entire profile.

The Sea Tech transmissometers used on these cruises have had a series of problems, some of them associated with component failures on the deeper casts. Other problems are associated with the temperature compensation unit in the transmissometer. These temperature related problems give rise to a variety of suspect behaviors: 1) high surface values (well beyond normal) that correlate with the time of day (highest at noon); 2) exponential decay within and below the mixed layer; 3) linear or exponential decays in the permanent thermocline; and 4) high cast to cast variability, even in deep water. As a result of these problems, some beam attenuation profiles are only good to certain depths. This depth is usually in the upper thermocline which does not allow us to compare the minimum in the profile with the theoretical clear water minimum. For these cases we choose a depth to which we believe the profile to be good and then compare this with the historical mean profile. The offset is then calculated at this depth and applied to that portion consider to be acceptable. The rest of the profile is designated as bad and set to -9.990. The ability to distinguish between genuine patterns and instrument problems can be difficult. The beam attenuation data should be considered qualitative and no attempt should be made to compare absolute numbers from one cruise to another.

- 4.2.6 *Fluorometer Calibration:* The fluorometer returns a voltage signal that is processed by the Seasoft software to a chlorophyll concentration. There is a standard instrument offset which is determined from the voltage reading on deck with the light sensor blocked off. Previous data reports have documented a field offset which is applied to the fluorometry data. We now believe this offset to be inappropriate and do not perform such a correction.
- 4.2.7 *Final Data Format:* Once all corrections have been applied the data are compared graphically against historical data envelopes. In particular, the modelled salinity and dissolved oxygen are plotted against potential temperature to ensure that no distortions to the profiles have been introduced as a result of the regression type modelling. The downcast data are then averaged in 2 dbar

bins, ready for dissemination. A descriptive header containing relevant cast information is appended to the top of the 2dbar data.

## 5.0 References

Bishop, J. (1986). The correction and suspended particulate matter calibration of Sea Tech transmissometer. *Deep-Sea Research* **33**, 121-134.

Sea-Bird Electronics, Inc. CTD Data Acquisition Software manual.



Figure 1.1 CTD Log sheet 1

CTD LOG SHEET							
Cruise:		Leg:			Station:		
Cast#:		Type:			Date:		
CTD Status	Time (lt)	Lat (1)	Long (1)	System(1)	Lat (2)	Long (2)	System (2)
In water							
On deck							
Niskin #	Niskin Serial #	Unique bottle ID	Desired depth (m)	Actual Depth (m or mb)	Time tripped	Temp at bottle fire	Comments
1							
2							
3							
4							
5							
6							
7							
8							
9							
10							
11							
12							
13							
14							
15							
16							
17							
18							
19							
20							
21							
22							
23							
24							

Figure 1.2 CTD Logsheet 2

CTD Model:		
Operator:		
SENSORS (tick)	SERIAL NUMBER	COMMENTS (offsets,performance,MLD,max,min...)
PRESSURE		
TEMPERATURE		
CONDUCTIVITY		
DISS. OXYGEN		
TRANSMISSOMETER		
FLUOROMETER		
ALTIMETER		
BOTTLES (type)		
OTHER		
Raw data filename:		Config. file:
Software version:		Averaging:
Computer(Zeos, Compaq):		Plots:
Backup name and medium:		
Additional comments:		
WEATHER AND SEA CONDITIONS		
Wind spd:	Wind dir:	Gusts:
Seastate:	Swell:	Local wind waves:
Sun intensity:	Cloud cover:	
AIR Temp:	Rainfall:	
Met. & Sea Synopsis(fronts,HP,LP,storms...):		

Figure 2. CTD Processing Stage 1

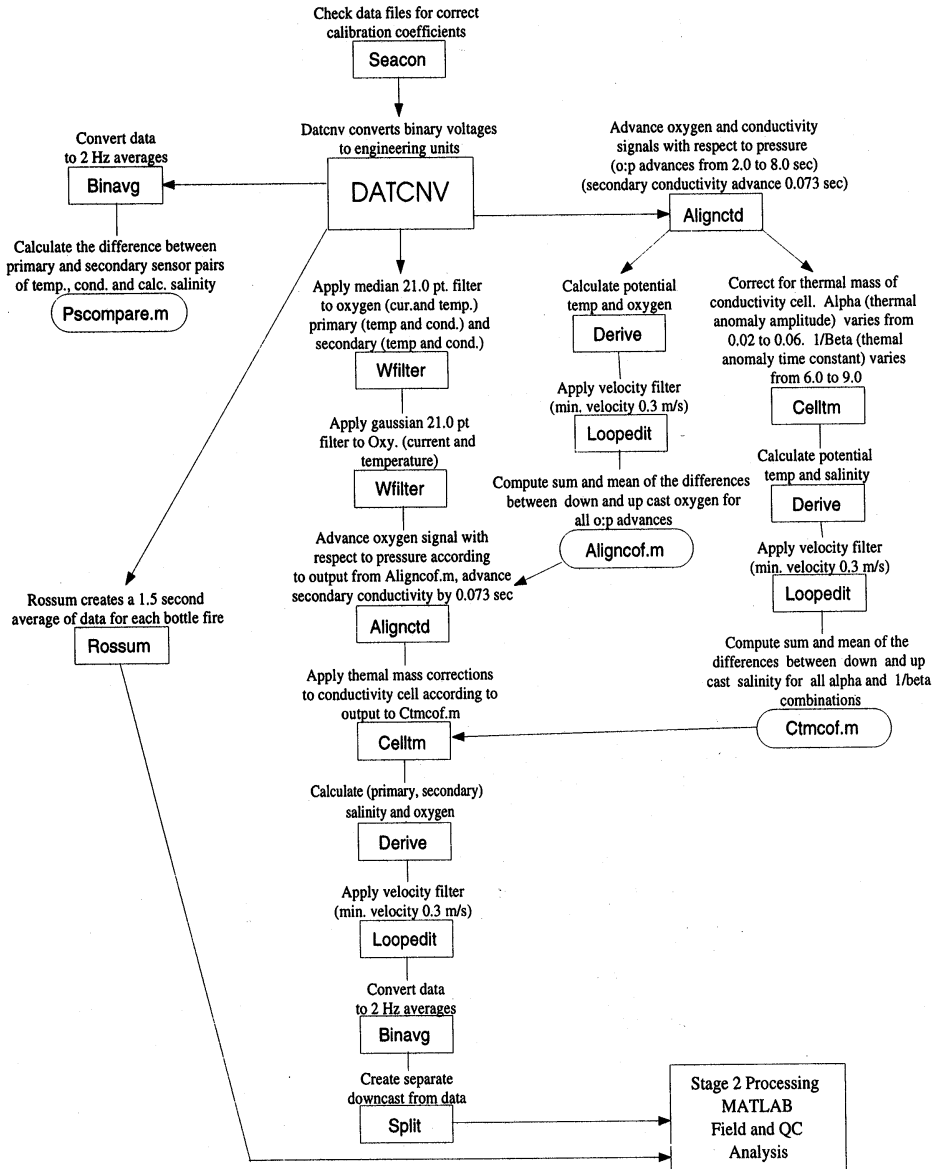

Figure 3.1 CTD Processing Stage 2

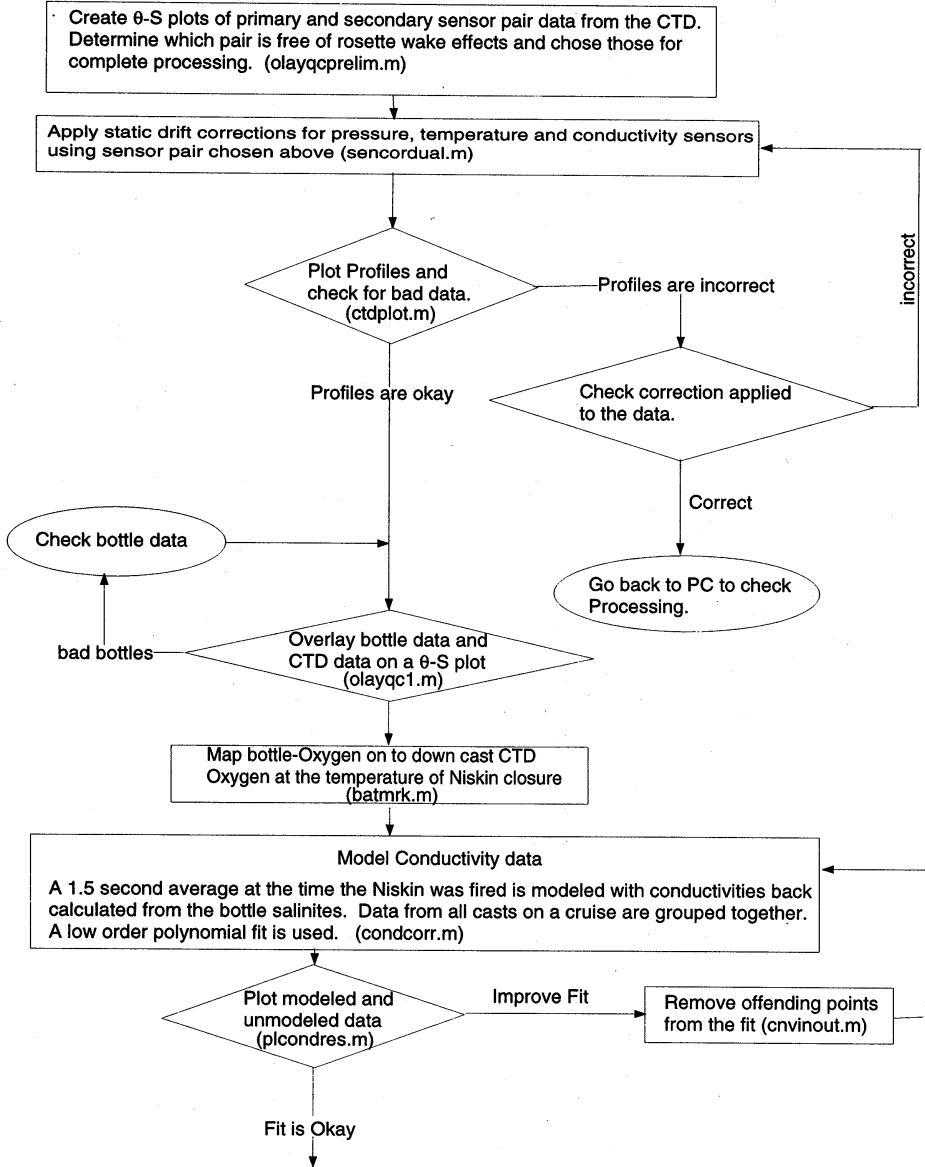
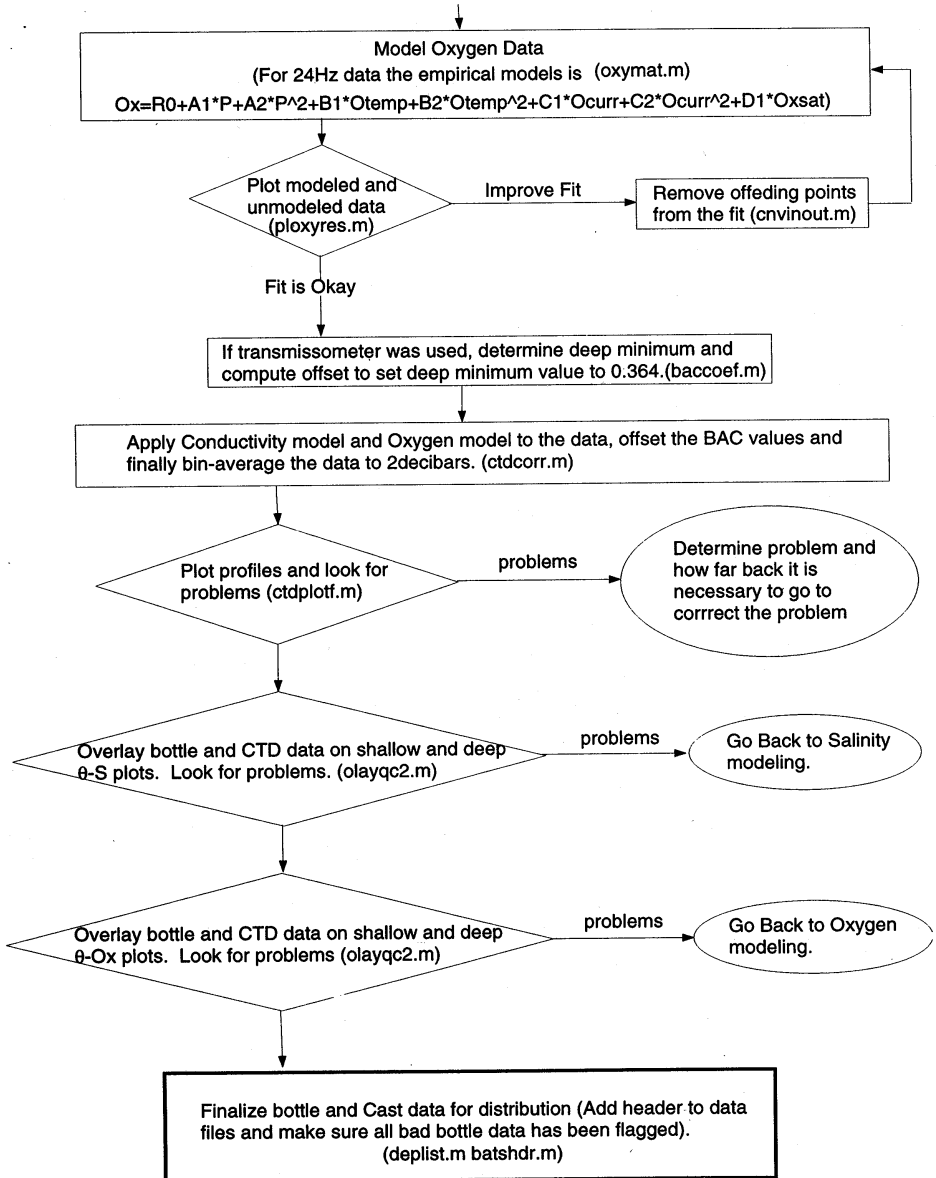

Figure 3.2 Continuation of Stage 2 Processing





*Bermuda Biological Station For Research, Inc.  
Bermuda Atlantic Time-series Study*

## **Chapter 4. Quality Control and Intercalibration**

Updated by: R. Johnson (April 1997), A. Michaels (March 1991)  
Prepared by: A. Michaels (October 1989)

### **1.0 Introduction**

The methods described in the next chapters provide the core set of data for the U.S. JGOFS, Bermuda Atlantic Time-series Study (BATS). The continuous CTD data described in Chapter 3 are calibrated by these bottle-collected data. Most of the techniques are standard and widely used. However, there are also numerous ways that the data can be inaccurate, from mechanical failure of the OTE bottles to accidents in the laboratory. Since these kinds of problems are unavoidable, we have set up a series of procedures for checking the BATS data both internally (for consistence with the other TS data) and externally (for consistence with historical data for this area and intercalibrations with other labs). These methods are used primarily to evaluate the salinity, dissolved oxygen, dissolved inorganic carbon, and nutrient data.

The quality control measures that we employ are a combination of formal and informal examinations of the data for inconsistencies and errors. The technicians who are making the measurements are well trained and make the same measurements month to month. They often spot an error in the data set as the number is being generated or as the data are recorded. They know the typical values for a depth and can spot many of the outliers. These points are not automatically discarded. The identification of an aberrant datum, either at this step or in the subsequent examinations, is cause for rechecking the previous steps in the data generation process (sampling, analysis, data entry and calculation, etc.) for inadvertent errors. If no inadvertent error can be found, then a decision must be made. If the datum is out of the bounds of possibility, it is likely to be discarded (see below). Discarded data are maintained in the master data files at BBSR, but will not be reported to U.S. JGOFS and NODC. For these official reportings, the number is replaced by a -9.99.

The next step in data quality control is to graph the data with depth and visually examine the profile. At this step, aberrant points can also become evident as deviations from the continuity of the profile. These deviations are checked as above. The other analyses of samples from the same OTE bottle are also examined to see if they all are aberrant, indicating that the bottle misfired or leaked. If a bottle appears to have leaked then it is appropriately flagged, which automatically prohibits the reporting of all measurements from this bottle.

- 1.1 Other graphical methods are also employed to examine the data. T-S diagrams are plotted and compared with historical data. Nutrients are plotted against temperature and density and against each other. Nitrate-phosphate plots have proved very useful in identifying both individual and systematic problems in these nutrient data.

The final examination procedure is the comparison with a carefully selected set of data called our QC windows. The original QC windows were compiled by G. Heimerdinger (NODC) from a number of cruises within 200 miles of Bermuda between 1975 and 1985. These are data sets that he feels are of high quality and also reflect the kinds of variation that would be seen at the BATS station. Salinity and oxygen are well represented in this data set, while nutrients are present for only four cruises. These original QC windows have now been superceded by the BATS QC windows which are based on the first 8 years of time-series data. These QC windows are available for all core discrete measurements on both depth and potential temperature intervals. The BATS data are graphically overlaid on the QC data and both systematic and individual variations noted and checked carefully, as above.

The most difficult problems to resolve are small systematic deviations from the QC envelopes. We are unwilling to automatically discard every deviation from the existing data, especially when we can find no reason that a previously reliable analysis should show the deviation. If the measurements were meant to come out invariant, there would be no reason to collect new data. Therefore, we anticipate that some of the data that we report will deviate from the QC envelope and we will then leave it to others to decide whether they agree with the values. We will make efforts to note these deviations in the cruise summaries that accompany each data report. We will not flag individual values.

Finally, we are constantly expanding the methods we use to check the data quality. For many measurements we have added internal standards, sample carry-overs between months and other procedures to prevent accuracy and standardization biases from giving false temporal change. Since the inception of BATS we have regularly been involved in intercomparison efforts with other laboratories and organizations, for a number of core measurements. These exercises have generally shown that sample analyses at BBSR agree well with those at other institutions. At times however, differences between the participating groups have existed which are not resolved due to the inadequacy of the exercise. BATS is now committed to involvement in well-managed, large scale inter-comparison exercises, preferably with use of certified reference materials, and our participation in smaller ad hoc exercises will be reduced.



*Bermuda Biological Station For Research, Inc.*  
*Bermuda Atlantic Time-series Study*

## Chapter 5. Salinity Determination

Updated by: S. Bell (1997); R. Johnson and R. Little (April 1996, April 1994); A. Michaels, R. Dow and N. Bates (April 1991)

Prepared by: A. Michaels and R. Dow (October 1989)

Modified from: Guideline Instruments (1978)

### 1.0 Scope and field of application

This procedure describes the method for the determination of seawater salinity. The method is suitable for the assay of oceanic levels (0.005–42). This method is a modification of one published by Guidline Instruments (1978).

### 2.0 Definition

The method determines the practical salinity (S) of seawater samples which is based on electrical conductivity measurements. The Practical Salinity Scale 1978 (PSS 78) defines the practical salinity of a sample of seawater in terms of the conductivity ratio ( $K_{15}$ ) of the conductivity of the sample at a temperature of 15°C and pressure of one standard atmosphere to that of a potassium chloride (KCl) solution containing 32.4356 g of KCl in a mass of 1 kg of solution.

### 3.0 Principle

A salinometer is used to measure the conductivity ratio of a sample of seawater at a controlled temperature. The sample is continuously pushed through an internal conductivity cell where electrodes initiate signals that are proportional to the conductivity of the sample. Using an internal preset electrical reference, these signals are converted to a conductivity ratio value. The number displayed by the salinometer is twice the conductivity ratio. The internal reference is standardized against the recognized IAPSO standard seawater.

### 4.0 Apparatus

*Guidline model 8400A Autosol Salinometer.* The Autosol has a 4 electrode cell which measures the conductivity ratio of a sample seawater in less than one minute. The salinity range of the instrument is about 0.005–42 and has a stated accuracy of  $\pm 0.003$  by the manufacturer. In practice, accuracies of 0.001 are possible.

## 5.0 Reagents

*IAPSO Standard Seawater.* Standard seawater for instrument calibration.

## 6.0 Sampling

- 6.1 Salinity samples are collected from OTE bottles at 35 depths from 0-4200m. Duplicate deep water samples are taken (>3000m).
- 6.2 The sample bottles are 250 ml clear borosilicate glass bottles with plastic screw caps. A plastic insert is used in the cap to form an effective airtight seal. Sample remaining after analysis is always left in the bottles to prevent salt crystal buildup due to evaporation and to maintain an equilibrium with the glass. When drawing a new sample, the old water is discarded and the bottle is rinsed three times with new sample water. The bottle is then filled to the shoulder and capped.
- 6.3 When sampling is complete, the set of salt bottles is taken into the temperature controlled laboratory. The cap of each bottle is momentarily removed, so that the inside of the cap and the threads of the bottle can be quickly dried with a Kimwipe and a clean plastic insert pressed in the bottle mouth. The cap is then replaced and firmly tightened. Samples are stored in the temperature controlled laboratory for later analysis (typically within 1-5 days of collection).
- 6.4 Every six months, the bottles are acid washed (1 M HCl), and rinsed and filled with Milli-Q water. After this cleaning they are rinsed five times with copious amounts of sample before filling.

## 7.0 Procedures

- 7.1 The samples are analyzed on a Guildline AutoSal 8400A laboratory salinometer using the manufacturer's recommended techniques. Samples are not run unless the ambient room temperature is  $\leq 2^{\circ}\text{C}$  below the salinometer bath temperature.
- 7.2 The salinometer is calibrated with IAPSO standard seawater. At least two standards are run prior to running the samples. The samples are run only if two standards give identical readings. At the end of the run, two new standards are run to check for instrument drift. The drifts are generally found to be zero. Using this procedure, the instrument can give a salinity precision of  $\pm 0.001\text{-}0.002$ .

## 8.0 Calculation and expression of results

The calculation of salinity is based on the 1978 definition of practical salinity (UNESCO, 1978). The following gives the necessary computation to calculate a salinity (S) given a conductivity ratio determined by the salinometer:

$$S = a_0 + a_1 R_T^{\frac{1}{2}} + a_2 R_T + a_3 R_T^{\frac{3}{2}} + a_4 R_T^2 + a_5 R_T^{\frac{5}{2}} \\ + \frac{T - 15}{1 + kT - 15} \left\{ b_0 + b_1 R_T^{\frac{1}{2}} + b_2 R_T + b_3 R_T^{\frac{3}{2}} + b_4 R_T^2 + b_5 R_T^{\frac{5}{2}} \right\}$$

Where:

$$\begin{aligned} a_0 &= 0.0080 & b_0 &= 0.0005 \\ a_1 &= -0.1692 & b_1 &= -0.0056 \\ a_2 &= 25.3851 & b_2 &= -0.0066 \\ a_3 &= 14.0941 & b_3 &= -0.0375 \\ a_4 &= -7.0261 & b_4 &= 0.0636 \\ a_5 &= 2.7081 & b_5 &= -0.0144 \\ k &= 0.0162 \end{aligned}$$

$R_T$  = conductivity ratio of sample (=0.5 salinometer reading)

$T$  = bath temperature of salinometer (°C)

$$\sum_{i=0}^5 a_i = 35.0000$$

$$\sum_{i=0}^5 b_i = 0.0000$$

for:

$$\begin{aligned} -2^\circ\text{C} &\leq T \leq 35^\circ\text{C} \\ 2 &\leq S \leq 42 \end{aligned}$$

## 9.0 Quality assurance

- 9.1 *Quality control*: The bottle salinities are compared with the downcast CTD profiles to search for possible outliers. The bottle salinities are plotted against potential temperature and overlaid with the CTD data. Historical envelopes from the time-series station are further overlaid to check for calibration problems or anomalous behavior.
- 9.2 *Quality assessment*: Replicate deep water (>3000m) samples are found to agree in salinity,  $\pm 0.001$ .
- 9.3 Regular intercalibration exercises are performed with other laboratories.

## 10.0 References

- Guildline Instruments. (1981). Technical Manual for 'Autosal' Laboratory Salinometer Model 8400.
- UNESCO. (1978). *Technical Papers in Marine Science*, **28**, 35pp.

## **Chapter 6. Determination of Dissolved Oxygen by the Winkler Procedure**

Updated by: S. Bell and R. Johnson (April 1997), R. Little (April 1996); R. Kelly and R. Little (May 1994); R. Dow (July 1992); A. Michaels (March 1992); A. Michaels, R. Dow and N. Bates (May 1991)  
Prepared by: A. Michaels and R. Dow (October 1989)  
Modified from: Strickland and Parsons (1972)

### **1.0 Scope and field of application**

This procedure describes a method for the determination of dissolved oxygen in seawater by means of an automated titration system which monitors changes in ultra-violet light transmission through the sample to determine the endpoint.<sup>1</sup> The method is suitable for the assay of oceanic levels, e.g. 0.5 to 350  $\mu\text{mol kg}^{-1}$  of oxygen in uncontaminated seawater and is based on the Carpenter (1965) modification of the traditional Winkler titration. This method is unsuitable for seawater containing hydrogen sulfide.

### **2.0 Definition**

The dissolved oxygen concentration of seawater is defined as the number of micromoles of oxygen gas ( $\text{O}_2$ ) per kilogram of seawater ( $\mu\text{mol kg}^{-1}$ ).

### **3.0 Principle of Analysis**

The chemical determination of oxygen concentrations in seawater is based on the method first proposed by Winkler (1888) and modified by Strickland and Parsons (1968). The basis of the method is the quantitative oxidation of iodide ions to iodine by the oxygen in the seawater sample; the amount of iodine thus generated is determined by titration with a standard thiosulfate solution. The endpoint is determined by the absorption of ultraviolet light by the tri-iodide ion. The amount of oxygen originally contained in the sample can then be calculated from the titer: one mole of  $\text{O}_2$  reacts with four moles of thiosulfate.

More specifically, dissolved oxygen is chemically bound to  $\text{Mn(II)OH}$  in a strongly alkaline medium which results in a brown floc/flocculent, manganic hydroxide ( $\text{MnO(OH)}_2$ ). After complete fixation of oxygen and formation of the mixed manganese (II) and (III) hydroxides floc, the sample is acidified to a pH between 2.5 and 1.0. This causes the precipitated hydroxides to dissolve, liberating the  $\text{Mn(III)}$  ions. The  $\text{Mn(III)}$

---

<sup>1</sup>. The automated titration system and the accompanying software used by BATS were designed by Robert Williams of Scripps Institute of Oceanography.

ions oxidize previously added iodide ions to iodine. Iodine forms a tri-iodide complex with surplus iodide ions. The complex formation is desirable because of its low vapor pressure and rapid decomposition when iodine is removed from the system. The iodine is then titrated with thiosulfate; iodine is reduced to iodide and the thiosulfate is oxidized to tetrathionate. The stoichiometric equations for the reaction described above are:

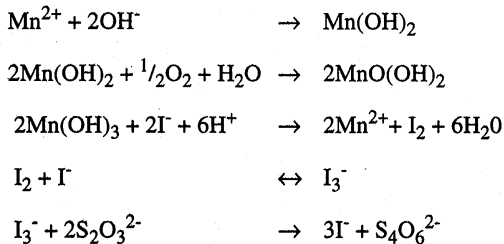

The thiosulfate can change composition and therefore must be standardized with a primary standard, typically potassium iodate. Standardization is based on the co-proportionation reaction of iodide with iodate, thereby forming iodine. As described above, the iodine binds with excess iodide, and the complex is titrated with thiosulfate. One mole of iodate produces three moles of iodine, an amount that reacts with six moles of thiosulfate.

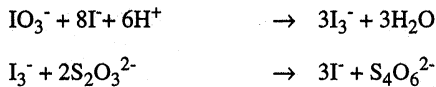

## 4.0 Apparatus

### 4.1 Sampling apparatus

- 4.1.1 *Sample flasks:* Pyrex<sup>®</sup> iodine determination (BOD) flasks of 140 ml nominal capacity with ground glass barrel stoppers. The precise volume of each stopper/flask pair is determined gravimetrically by weighing with Milli-Q water. It is essential that each individual stopper/flask pair be marked to identify them and that they be kept together for subsequent use.
- 4.1.2 *Pickling reagent dispensers:* two dispensers capable of dispensing 1 ml aliquots of the pickling reagents. The accuracy of these dispensers should be 1% (i.e. 10  $\mu\text{l}$ ).
- 4.1.3 *Tygon<sup>®</sup> tubing:* long enough to reach from spigot to the bottom of the sample bottle.

4.1.4 *Thermometers*: directly after sampling a thermometer is used to measure the water temperature to within 0.5°C.

#### 4.2 *Automated titration apparatus*

4.2.1 *Metrohm 655 Dosimat burette*: a piston burette capable of dispensing 1 to 10 ml of KIO<sub>3</sub> for blank determination and standardization.

4.2.2 *Metrohm 665 Dosimat Oxygen Auto-titrator*: a piston burette capable of dispensing 2 µl aliquots of thiosulfate (the Dosimat 665), an ultra-violet light source UV and a detector to measure the change in UV transmission through the sample.

4.2.3 *PC computer*. The burette, endpoint detector and A/D converter are controlled by an IBM compatible PC, in a system designed by R. Williams (SIO).

4.2.4 *Thermometers*. Platinum resistance temperature sensors are mounted to the bottles containing the potassium iodate standard and the thiosulfate solution, in order to correct the volumes dispensed to the corresponding volume at 20°C.

4.2.5 *Dispenser*: capable of delivering 1 ml aliquots of the sulfuric acid solution.

4.2.6 *Magnetic stirrer and stir bars*.

## 5.0 Reagents

5.1 *Manganese (II) chloride* (3M: reagent grade): 600 g of MnCl<sub>2</sub>•4H<sub>2</sub>O are dissolved in approximately 600 ml of Milli-Q water. After complete dissolution the solution is filtered into a Class A volumetric flask and then diluted with Milli-Q to a final volume of 1000 ml. The reagent is twice gravity filtered through 24µm particle retention paper filters, and stored in an amber plastic bottle.

5.2 *Sodium Iodide* (4M: reagent grade) and *sodium hydroxide* (8M: reagent grade): 600 g of NaI are dissolved in approximately 600 ml of Milli-Q water. 320 g of NaOH are added to the solution, usually in 80 g aliquots, while it is cooling in a water bath. The solution is then twice gravity filtered through 24µm particle retention paper filters into a Class A volumetric flask and diluted to a final volume of 1000 ml with Milli-Q. The reagent is stored in an amber glass bottle.

- 5.3 *Sulfuric Acid (50% v/v)*: 500 ml of reagent grade concentrated  $\text{H}_2\text{SO}_4$  are slowly added to 500 ml of Milli-Q water. The mixture is cooled in a water bath during the addition of acid and stored in a glass bottle.
- 5.4 *Sodium Thiosulfate (0.18 M; reagent grade)*: Approximately 45 g of  $\text{Na}_2\text{S}_2\text{O}_3 \cdot 5\text{H}_2\text{O}$  are dissolved in Milli-Q water to a final volume of 1000 ml. This solution is stored in an amber glass bottle in the refrigerator until use.
- 5.5 *Potassium Iodate Standard (0.0100 N)*: A commercial standard (CSK standards solution) is used as the primary standard, purchased from Wako Chemicals (Wako Chemicals USA Inc. 1600 Bellwood Road, Richmond, VA 23237, USA. Tel: 804 271-7677).

## 6.0 Sampling

Collection of water from the OTE bottle must be done soon after opening, preferably before any other samples have been drawn. This is necessary to minimize exchange of oxygen with the head space in the OTE bottle which typically results in contamination by atmospheric oxygen.

- 6.1 Samples are collected at all depths in gravimetrically volume calibrated BOD flasks from each OTE bottle. The first sample is termed O2-1. For precision estimates and redundancy at extrema, a further two or more samples are drawn which are termed O2-2, O2-3, etc. Typically 30% of the depths are sampled in triplicate.
- 6.2 Before the oxygen sample is drawn the spigot on the OTE bottle is opened while keeping the breather valve closed. If no water flows from the spigot it is unlikely that the bottle has leaked. If water leaks, it is probable that the OTE bottle has been contaminated with water from shallower depths. The possibility of contamination is noted on the cast sheet for the appropriate bottle.
- 6.3 The oxygen samples are drawn into the individually iodine determination flasks. It is imperative that the flask and stopper are a matched pair. If replicates are to be taken from a particular OTE bottle, they are drawn immediately following the first sample (O2-1).
- 6.4 Great care is taken to avoid introducing air bubbles when drawing the sample. A 30–50 cm length of Tygon<sup>®</sup> tubing is connected to the OTE bottle spout. The end of the tube is elevated before the spout is opened to prevent the trapping of bubbles in the tube. With the water flowing, the tube is placed in the bottom of the horizontally held



sample flask in order to rinse the sides of the flask and the stopper. The flask is inverted upright for a few seconds so as to flush out any air bubbles that may be adhering to the flask walls. The flask is then returned to an upright position and four to five volumes of water are allowed to overflow. The tube is then slowly withdrawn from the flask while water is still flowing.

- 6.5 Immediately after obtaining the seawater sample, the tip of an automatic dispenser is submerged well into the sample to introduce 1 ml of manganous chloride into the flask. This is followed by addition of 1 ml of sodium iodide-sodium hydroxide solution from a second dispenser, also by submerging the tip in the sample.
- 6.6 The stopper is carefully placed in the bottle ensuring that no bubbles are trapped inside. The bottle is vigorously shaken, then reshaken approximately 20 minutes later after the precipitate has settled to the bottom of the bottle.
- 6.7 Once all oxygen samples from a particular OTE bottle have been drawn, the temperature of the water from the bottle is measured and recorded.
- 6.8 Sample bottles are stored upright in a cool, dark location and the necks are sealed with surface seawater. Samples are analysed after a period of at least 6-8 hours but within 36 hours. The samples are stable in this time period.

## 7.0 Titration Procedures

- 7.0.1 The basic steps in titrating oxygen samples differ little regardless of the system used. First the precise concentration of the thiosulfate must be determined. Next the blank - the impurities in the potassium iodate primary standards which participate in the series of oxidation-reduction reactions involved in the analysis - is calculated. Once the standard titer and blank have been determined, the samples can be titrated.
- 7.0.2 The auto-titrator used by BATS has a UV detector which measures the transmission of ultra-violet light through the sample (standard, blank or seawater-sample) as the thiosulfate is added. Initially the Metrohm 665 Dosimat rapidly dispenses 0.2 N thiosulfate. As the changes in UV absorption decrease the thiosulfate addition rate is slowed, and finally the continuous addition is stopped. The endpoint is approached by addition of ever-smaller increments of thiosulfate until no further change in absorption is detected, indicating that the endpoint has been passed. The actual end is determined by a least squares linear fit using a group of data points just prior to the endpoint, where the slope of the titration curve is steep, and a group of points after the endpoint, where the slope of the curve is close to zero. The intersec-

tion of the two lines of best fit is taken as the endpoint. Reproducibility should be better than  $0.01 \text{ ml l}^{-1}$ . Standardization, blank determination, and sample analysis are described below.

### 7.1 *Standardization:*

- 7.1.1 Using the Metrohm 655 Dosimat, 10 ml of standard potassium iodate (0.0100 N) are dispensed into a flask containing about 15 ml of Milli-Q water and a stir bar. The solution is swirled, and 1 ml of 50% sulfuric acid solution added. The sides of the flask are rinsed with additional Milli-Q and the flask swirled to ensure the acidic solution is well mixed before the addition of the pickling reagents.
- 7.1.2 1 ml of sodium iodide-sodium hydroxide reagent and then 1 ml of manganese chloride reagent are added to the acidified solution. The solution is mixed thoroughly after each addition. The solution is gently swirled and the sides of the flask rinsed with Milli-Q water and filled to the neck.
- 7.1.3 Titration of the liberated iodine with thiosulfate is started immediately, as described in Section 7.02. Reproducibility of standards should be better than  $0.01 \text{ ml l}^{-1}$ .
- 7.1.4 The mean value of at least four replicate standards is determined. The standard titer must have standard deviation of less than  $\pm 0.006 \text{ ml l}^{-1}$  before samples can be run. Standards are run periodically throughout the time that samples are being titrated.

### 7.2 *Blank determination:*

- 7.2.1 1 ml of standard potassium iodate is added to a flask containing about 15 ml of Milli-Q water and a stir bar, using the Metrohm 655 Dosimat. The solution is swirled and then 1 ml of 50% sulfuric acid solution is added. The sides of flask are rinsed with additional Milli-Q and the flask swirled to ensure an acidic solution before the addition of the pickling reagents.
- 7.2.2 Before beginning the titration the pickling reagents are added. 1 ml of sodium iodide-sodium hydroxide reagent and 1 ml of manganese chloride reagent are added to the flask. The solution is gently swirled and the sides of the flask rinsed with Milli-Q water to ensure mixing. The flask is filled to just below the neck with Milli-Q water and then the blank is titrated to the endpoint, as described in Section 7.02.

- 7.2.3 A second 1 ml of the standard potassium iodate is added to the same solution which is again titrated to the end point. The difference between the first and second titration is the potassium iodate blank. Both positive or negative blanks are found.

### 7.3 Sample analysis:

- 7.3.1 Samples are analysed after at least 8 hours from when they were drawn. The water in the neck is carefully removed, taking care to minimize disturbance of the precipitate. The top of the flask is wiped with a KimWipe to remove any remaining moisture and the stopper carefully removed.
- 7.3.2 1 ml of 50% sulfuric acid and a stir bar are added to the flask. Care is taken to minimize disturbance of the precipitate.
- 7.3.3 Samples are titrated as described in Section 7.02.

## 8.0 Calculation and expression of results

The calculation of oxygen concentration ( $\mu\text{mol l}^{-1}$ ) from this analysis follows in principle the procedure outlined by Carpenter (1965).

$$O_2 \text{ (ml l}^{-1}\text{)} = \frac{(R - R_{b/k}) V_{\text{IO}_3} \cdot M_{\text{IO}_3} \cdot E}{(R_{\text{Std}} - R_{b/k}) (V_b - V_{\text{reg}})} - \frac{DO_{\text{reg}}}{V_b}$$

Where:

- $R$  = Sample titration (ml)  
 $R_{b/k}$  = Blank as measured above (ml)  
 $V_{\text{IO}_3}$  = Volume of  $\text{KIO}_3$  standard (ml)  
 $M_{\text{IO}_3}$  = Molarity of standard  $\text{KIO}_3$  (mol/l)  
 $E$  = 5,598 ml  $\text{O}_2$ /equivalent  
 $R_{\text{Std}}$  = Volume used to titrate standard (ml)  
 $V_b$  = Volume of sample bottle (ml)  
 $V_{\text{reg}}$  = Volume of reagents (2 ml)  
 $DO_{\text{reg}}$  = oxygen added in reagents

- 8.1 The additional correction for  $DO_{\text{reg}}$  of 0.0017 ml oxygen added in 1 ml manganese chloride and 1 ml of alkaline iodide has been suggested by Murray, Riley and Wilson (1968).

- 8.2 *Conversion to  $\mu\text{mol kg}^{-1}$* : To make an accurate conversion to  $\mu\text{moles kg}^{-1}$  two corrections are needed: (1) a correction for the actual amount of thiosulfate delivered by the burette (which is temperature dependent); and (2) a correction for the volume of the sample at the time it was drawn. Both calculations are undertaken automatically in many versions of software driven titration. Two pieces of information are required: (a) the temperature of the sample (and bottle) at the time of fixing; the reasonable assumption being that the two are the same; (b) the temperature of the thiosulfate at the time of dispensing. Some versions of the automatic titration may also call for *in situ* temperature, as well as salinity, which allow for the calculation of oxygen solubility and thus the percentage saturation and AOU.

## 9.0 Quality assurance

- 9.1 *Quality Control*: Thirty percent of the oxygen samples are replicated in at least triplicate. Replicates are taken at depths where the *in situ* CTD oxygen profile indicates extreme points. A mean squared difference (equivalent to a standard deviation of repeated sampling) is the measure of precision for these profiles. As this replication takes into account all sources of variability (e.g. sampling, storage, analysis) it gives a slightly larger imprecision than indicated by the analytical precision of the titration (e.g. repeated measures of standards in the lab). In addition, periodic precision tests are done by collection and analysis of 5–10 samples from the same OTE bottle. This precision should be better than  $0.01 \text{ ml l}^{-1}$ . Field precision can vary from 0.005 to 0.03 depending on the sea conditions and the performance of the auto-titrator. Samples are reduced to oxygen concentrations prior to the next cruise to identify any degradation of the precision before additional profiles are collected and analysed.
- 9.2 *Quality assessment*: No absolute standard exists for oxygen analysis. Standards are made by gravimetric and volumetric measurements of reagent grade chemicals. Standard solutions are relatively stable and provide an early warning of errors by changes in their titer. Profiles of oxygen are examined visually and numerically. At any depth where the replicates differ by  $0.02 \text{ ml l}^{-1}$  or greater, the samples are carefully scrutinized. The profile is compared with the historical profiles for consistency, particularly in the deep water. These profiles are also compared with the CTD oxygen sensor. Although CTD oxygen sensors are very imprecise and inaccurate, they provide a continuous record. Deviations from the general shape of the profile by a single oxygen sample is evidence of inaccuracy in the wet oxygen measurement.

## 10.0 Acknowledgments

We would like to thank Robert Williams (Scripps Institute of Oceanography) for his time and patience in getting our current automated titration system up and running. With his

assistance we have greatly improved the precision of oxygen measurements made at BATS.

## 11.0 References

- Carpenter, J.H. (1965). The Chesapeake Bay Institute. Technique for the Winkler oxygen method. *Limnol. Oceanogr.*, **10**, 141–143.
- Grasshoff, K. Ehrhardt, M, and K. Kremling (1983). Methods of Seawater Analysis. Grasshoff, Ehrhardt and Kremling, eds. Verlag Chemie GmbH. 419 pp.
- Murray J.N., Riley, J.P. and Wilson, T.R.S. (1968). The solubility of oxygen in Winkler reagents used for the determination of dissolved oxygen. *Deep-Sea Res.*, **15**, 237–238.
- Strickland, J.D.H., and Parsons, T.R. (1968). Determination of dissolved oxygen. in *A Practical Handbook of Seawater Analysis*. Fisheries Research Board of Canada, Bulletin, **167**, 71–75.
- Williams, P.J.leB., and Jenkinson, N.W. (1982). A transportable microprocessor-controlled precise Winkler titration suitable for field station and shipboard use. *Limnol. Oceanogr.*, **27** (3), 576–584.
- Winkler, L.W. (1888). Die Bestimmung des in Wasser gelösten Sauerstoffes. *Berichte der Deutschen Chemischen Gesellschaft*, **21**: 2843–2855.



## Chapter 7. Determination of Total Inorganic Carbon ( $C_T$ ) by the Coulometric Procedure

Updated by: N. Bates (April 1997)  
Prepared by: N. Bates (June 1992)

### 1.0 Scope and field of application

This procedure describes a method for the determination of total dissolved inorganic carbon ( $C_T$ ) in sea water, expressed as moles of carbon per kilogram of sea water. A highly precise automatic gas extraction coulometric detection system is described. The method is suitable for the assay of oceanic levels of total dissolved inorganic carbon (1800-2400  $\mu\text{mol kg}^{-1}$ ) and also for higher levels such as are found in the Black Sea (3800-4300  $\mu\text{mol kg}^{-1}$ ). For a more definitive and comprehensive treatment of the analysis, the reader is referred to the D.O.E. (1994) handbook (Dickson, A.G., and Goyet, C., eds.), Johnson *et al.* (1993) and the SOMMA manual (Johnson, 1992). The D.O.E. (1994) handbook by Dickson and Goyet provides protocols for other carbon dioxide system parameters (i.e. pH, alkalinity,  $p\text{CO}_2$ ).

### 2.0 Definition

The total dissolved inorganic carbon content of seawater is defined as:

$$C_T = [\text{CO}_2^*] + [\text{HCO}_3^-] + [\text{CO}_3^{2-}]$$

where brackets represent total concentrations of these components in solution ( $\mu\text{mol kg}^{-1}$ ) and  $[\text{CO}_2^*]$  represents the concentration of all unionized carbon dioxide, whether present as  $\text{H}_2\text{CO}_3$  or as  $\text{CO}_2$  (UNESCO, 1991).  $C_T$  can also be referred to as total carbon dioxide ( $\text{TCO}_2$ ).

### 3.0 Principle of Analysis

Total dissolved inorganic carbon ( $C_T$ ) is measured by acidifying a seawater sample to convert  $\text{HCO}_3^-$  and  $\text{CO}_3^{2-}$  to undissociated  $\text{CO}_2$ , and then extracting this  $\text{CO}_2$  as a gas, trapping and titrating the amount evolved (Johnson *et al.*, 1987, 1993). A high degree of precision and accuracy is maintained by using a computer-controlled automated dynamic headspace analyzer that extracts total carbon dioxide ( $C_T$ ) from seawater using a SOMMA (Single-Operator Multiparameter Metabolic Analyzer) designed by K. Johnson of Brookhaven National Laboratory (Johnson, 1992, Johnson *et al.*, 1993), now

commercially available from the University of Rhode Island. This apparatus is coupled to a commercial coulometer that detects the extracted CO<sub>2</sub> (Huffman, 1977, Lindberg and Cedergren, 1978).

The analytical system forces a sample (either seawater, Na<sub>2</sub>CO<sub>3</sub> standard solution or distilled water) into a volume-calibrated pipette using a pressurized headspace gas of air. This known sample volume (~30 ml) is then dispensed into a stripping chamber previously acidified with ~1.5 ml of phosphoric acid (the chamber and phosphoric acid are purged with pure nitrogen or helium carrier gas prior to the addition of each sample). CO<sub>2</sub> gas evolved from the acidified sample is then passed through a thermostated condenser (4°C) and a magnesium perchlorate trap to remove water vapor. Any acidic or reactive gases are removed by passing through activated silica gel trap (ORBO 53<sup>®</sup> tube).

The amount of CO<sub>2</sub> gas extracted from the acidified sample by a continuous flow of pure N<sub>2</sub> through the chamber is determined coulometrically by trapping and titrating the CO<sub>2</sub> with a DMSO based absorbent containing ethanolamine. The resulting hydroxyethylcarbamic acid which is formed with electrochemically generated hydroxide ions is titrated to maintain the absorbing solution at constant pH. Relevant chemical equations occurring in the solution are:

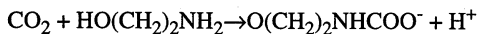

Hydroxide ions are generated by electrolysis of water at the platinum cathode and the total amount of CO<sub>2</sub> extracted from the sample is based on the time integrated current of the OH<sup>-</sup> generated to maintain the absorbing solution at a constant, colorimetrically defined pH.

The determination of seawater total dissolved inorganic carbon is calibrated with known volumes of pure CO<sub>2</sub> (Johnson, 1992, Johnson *et al.*, 1985, 1987, 1993, Wilke *et al.*, 1993).

## 4.0 Apparatus

4.1 *SOMMA (Single-Operator Multi-Parameter Metabolic Analyzer)*, available from University of Rhode Island. Includes:

4.1.1 Eight port gas chromatography valve

4.1.2 Two loops of stainless steel tubing of known volume

4.1.3 Three thermistors accurate to ± 0.05°C



- 4.1.4 SOMMA glassware (e.g. stripping chamber, calibrated water-jacketed pipette, water-cooled condenser, aerosol traps, magnesium perchlorate trap)
  - 4.1.5 Temperature controlled water bath circulators
  - 4.1.6 Temperature controlled sample bottle holder
  - 4.1.7 The newer versions have a Sea-Bird conductivity cell for determining salinity.
- 4.2 A model 5011 CO<sub>2</sub> coulometer (UIC Inc., P.O. Box 863, Joliet, IL 60434)
- 4.2.1 Coulometer cell (temperature controlled)
  - 4.2.2 Electrodes: platinum spiral cathode and silver rod anode
  - 4.2.3 Rubber cell top, silicone O-ring
  - 4.2.4 Stir bar
- 4.3 *Computer system*
- 4.3.1 PC (e.g. 286 or higher)
  - 4.3.2 Printer
  - 4.3.3 Software GW Basic program (K. Johnson)
- 4.4 *Sampling equipment*
- 4.4.1 Clean 500 or 1000 ml borosilicate reagent bottles and ground-glass stoppers
  - 4.4.2 Apiezon L grease
  - 4.4.3 Tygon<sup>®</sup> drawing tube
  - 4.4.4 Pipette to dispense mercuric chloride
- 4.5 *Other*: Barometer, e.g. Paroscientific transducer; Circulator; Chiller

## 5.0 Reagents

- 5.1 *Compressed gases*:

- 5.1.1 Carrier gas: Nitrogen (>99.9995%) or Helium (>99.995%)
- 5.1.2 Calibration gas: CO<sub>2</sub> (>99.999%)
- 5.1.3 Headspace gas: Air (350 μatm CO<sub>2</sub>)
- 5.2 *Phosphoric acid* (reagent grade): Phosphoric acid, diluted with Milli-Q water by a factor of 10:1 (~8%) is used to acidify seawater samples.
- 5.3 *Magnesium perchlorate* (reagent grade): For the removal of water vapor.
- 5.4 *Activated silica gel*: For the removal of reactive acidic gases. Glass tubes (ORBO-53 traps) with activated silica are custom-made by Supelco Inc., U.S.A.
- 5.5 *Cathode solution*: UIC Coulometrics, Inc. proprietary mixture of water, ethanolamine, tetraethylammonium bromide, and thymolphthalein in solution in dimethyl sulfoxide (DMSO).
- 5.6 *Anode solution*: UIC Coulometrics, Inc. proprietary solution containing saturated potassium iodide in water and DMSO.
- 5.7 *Potassium iodide* (reagent grade): Added to anode solution.
- 5.8 Saturated solution of *Mercuric chloride*:
- 5.9 *Ascarite*: For the removal of CO<sub>2</sub> from the carrier gas.
- 5.10 *Sodium carbonate* (optional): Na<sub>2</sub>CO<sub>3</sub> (99.95% pure: Alkometric standard, Fisher Scientific Co.): Six solutions are prepared for standard calibration ranging in concentration from distilled water to 500, 1000, 1500, 2000, and 2500 μmol C.kg<sup>-1</sup>.

## 6.0 Sampling

- 6.1 Seawater sample for C<sub>T</sub> analysis are collected in the Teflon-coated OTE bottles either on the General Oceanics rosette or individually mounted on stainless steel hydrowire. C<sub>T</sub> seawater is collected after the first and any replicate oxygen samples.
- 6.2 The samples are drawn into 12 individually numbered, clean, one liter borosilicate glass bottles. Water is also drawn into at least two duplicate bottles. In obtaining sea-

water samples, care is taken to minimize turbulence and to prevent the retention of air bubbles in the bottles. A 30-50 cm length of Tygon<sup>®</sup> tubing is connected to the OTE bottle spout. The end of the tube is elevated before the spout is opened to prevent the trapping of bubbles in the tube. With the water flowing, the tube is placed in the bottom of the bottle. The bottle is slowly rotated and the side of the bottle tapped with the stopper to ensure that no air bubbles adhere to the bottle walls. At least two to three volumes of water are allowed to overflow from the bottle. A headspace of >1% of the bottle volume is left to allow for water expansion. 200 µl of saturated mercuric chloride is then added to the sample bottle to prevent further biological activity. The bottle neck is dried with a Kim-Wipe stick and then the bottle is sealed with an Apiezon grease coated ground-glass stopper, ensuring that it remains gas-tight. Rubber bands are placed around the lip of the bottle and stopper in a criss-cross manner as a further precaution.

6.3 The samples are then stored in a cool, dark location until analysis.

## 7.0 Procedures

7.1 *Bottle preparation:* Bottles should be carefully cleaned before use. Used bottles are emptied and any grease on the bottle neck is removed with kim-wipes. Bottles are thoroughly washed with a commercial detergent, then rinsed with a 10% HCl solution. Copious rinsing with Milli-Q/distilled water is followed by an acetone rinse. The bottles are then allowed to air dry for an hour and sealed with ground-glass stoppers.

### 7.2 Maintenance of SOMMA-Coulometer system

7.2.1 The titration cell is cleaned with copious rinses of Milli-Q water and a rinse with acetone. The sidearm of the cell is then filled with acetone which is then left to drain overnight through the frit separating the cathode compartment from the sidearm. The cell is then rinsed with Milli-Q water and left to dry overnight at 55°C.

7.2.2 The rubber top, electrodes, stir bar and perchlorate trap are thoroughly cleaned with Milli-Q water.

7.2.3 The titration cell, rubber stopper, stir bar, electrodes, magnesium perchlorate glass trap, and Teflon carrier gas lines are dried overnight at 55°C.

7.2.4 The ORBO-53 tubes and magnesium perchlorate traps are renewed with each newly prepared coulometer cell.

### 7.3 Determination of the background level

- 7.3.1 Each analysis session, fresh coulometer cell solutions are used.
- 7.3.2 An aliquot of phosphoric acid is introduced into the coulometer cell. CO<sub>2</sub>-free N<sub>2</sub> carrier gas is allowed to run through the SOMMA system and into coulometer cell. Once the background titration rate is stable, a background level is determined by averaging over a 10 minute period.

### 7.4 Calibration

- 7.4.1 The electrical calibration of the coulometer is not perfectly accurate and the current efficiency of the electrode processes occurring in the coulometer cell have been shown to vary from 100% (Johnson *et al.*, 1993, D.O.E., 1994). It is therefore necessary to calibrate the coulometer using known volumes of pure CO<sub>2</sub> or with a suite of Na<sub>2</sub>CO<sub>3</sub> solutions (e.g. Goyet and Hacker, 1992). The amount of C<sub>T</sub> titrated by the coulometer is recorded by microcomputer.
- 7.4.2 Valves that operate the CO<sub>2</sub> calibration and sample extraction systems are controlled by microcomputer (Johnson 1992, Johnson *et al.*, 1993).
- 7.4.3 A stainless-steel loop of known volume is filled with pure CO<sub>2</sub>. The loop is then flushed with carrier gas into the coulometer cell and titrated. A mean calibration factor is calculated from two different loops.
- 7.4.4 Standard concentrations of C<sub>T</sub> ranging from 500 to 2500 μmol.C kg<sup>-1</sup> can also be prepared using distilled water and variable amounts of dried Na<sub>2</sub>CO<sub>3</sub> salt (D.O.E., 1994, Goyet and Hacker, 1992). Sodium carbonate solutions are treated as if they were seawater samples. A blank standard solution (distilled water without any Na<sub>2</sub>CO<sub>3</sub>) is also prepared.

### 7.5 Analysis of a seawater sample

- 7.5.1 Once the background level and calibration factor have been determined satisfactorily, the coulometric system can be used to analyze seawater samples.
- 7.5.2 The stripping chamber is drained of any previous sample. An aliquot of phosphoric acid (~1.5 ml) is dispensed into the stripping chamber. The pipette and the silicone sample lines are flushed with a new sample. The pipette is then filled and allowed to drain into the stripping chamber. CO<sub>2</sub> gas evolved is transferred with carrier nitrogen or helium gas to the coulometer cell and titrated.

7.6 *Post-analysis*: The dispensing and stripping systems are cleaned by rinsing with Milli-Q/distilled water.

## 8.0 Calculation and expression of results

The amount of  $C_T$  titrated by the coulometer for a seawater sample is multiplied by the calibration factor (slope of calculated vs. measured concentration), giving the seawater  $C_T$ , expressed in  $\mu\text{mol kg}^{-1}$  of seawater, computed as follows:

$$C_T = \left( \frac{N - (b \cdot t)}{c} \right) \left( \frac{1}{V \cdot p} \right)$$

Where:

$C_T$	=	total dissolved inorganic carbon ( $\mu\text{mol kg}^{-1}$ )
$N$	=	coulometer reading in counts
$b$	=	background level of the system
$c$	=	coulometer calibration factor
$t$	=	time required to measure pipette
$V$	=	volume of seawater sample
$p$	=	density of seawater

## 9.0 Quality assurance

### 9.1 *Quality control*:

Written instructions outlining the standard operating procedures are maintained and continually reviewed and updated. Standard operating procedures are kept within guidelines proposed by the D.O.E. CO<sub>2</sub> survey science team (D.O.E., 1994).

### 9.2 *Quality assessment*:

9.2.1 The background level is usually within  $0.1 \mu\text{g C min}^{-1}$ .

9.2.2 The recovery of CO<sub>2</sub> compared to theory during gas calibration is maintained at better than 0.2%. The two gas loops must give the same calibration factor within 0.05% before analysis of samples begin.

- 9.2.3 Within-bottle replicate and between-bottle duplicate measurement of over 100 samples give a standard deviation of approximately  $0.3 \mu\text{mol kg}^{-1}$  and  $0.5 \mu\text{mol kg}^{-1}$  respectively, well within guidelines proposed (D.O.E., 1994).
- 9.2.4 Stable seawater certified reference materials (CRM's), supplied by A. Dickson (Scripps Institute of Oceanography), are analyzed regularly to maintain the day to day and year to year accuracy of the measurements. Analyses of these reference materials at BBSR are within the standard deviation of the mean reported by the Scripps Institution of Oceanography ( $0.3 \mu\text{mol kg}^{-1}$ ). Intercomparison exercises are also undertaken with other laboratories.

## 10.0 References

- D.O.E. (1994). *Handbook of methods for the analysis of the various parameters of the carbon dioxide system in seawater; version 1.0*, edited by A.G. Dickson and C. Goyet.
- Goyet, C., and Hacker, S.D. (1992). Procedure for calibration of a coulometric system used for total inorganic carbon measurements in seawater, *Marine Chemistry*, **38**, 37-51.
- Huffman, E.W.D. Jr. (1977). Performance of a new automatic carbon dioxide coulometer. *Microchemical Journal*, **22**, 567-573.
- Johnson, K.M. (1992). Single-Operator Multiparameter Metabolic Analyzer (SOMMA) for Total Carbon Dioxide ( $C_T$ ) with Coulometric Detection. SOMMA Manual 1.0, January 1992, Brookhaven National Laboratory, 70 pp.
- Johnson, K.M., King, A.E., and Sieburth, J.McN. (1985). Coulometric  $\text{TCO}_2$  analyses for marine studies: an introduction. *Marine Chemistry*, **16**, 61-82.
- Johnson, K.M., Sieburth, J.M., Williams, P.J. leB., and Brandstrom, L. (1987). Coulometric total carbon dioxide analysis for marine studies: automation and calibration. *Marine Chemistry*, **21**: 117-133.
- Johnson, K.M., Wills, K.D., Butler, B.D., Johnson, W.K. and Wong, C.S. (1993). Coulometric total carbon dioxide analysis for marine studies: maximizing the performance of an automated gas extraction system and coulometric detector. *Marine Chemistry*, **44**, 167-188.
- Lindberg, A.O., and Cedergren, A. (1978). Automatic coulometric titration with photometric endpoint detection. Part II. Coulometric determination of nanomolar amounts of carbon dioxide by non-aqueous titration. *Analytica Chimica Acta*, **96**, 327-333.
- UNESCO. (1991). Reference materials for oceanic carbon dioxide measurements. In: *Report of the Sub-panel on Standards for  $\text{CO}_2$  Measurements of the Joint Panel on Oceanographic Tables and Standards*. Report of meeting in Acapulco, Mexico, 29-31 August 1988. UNESCO Technical Papers in Marine Science.

Wilke, R., Wallace, D.W.R., and Johnson, K.M. (1993). A water based gravimetric method for the determination of gas sampling loop volume. *Analytical Chemistry*, **65**, 2403-2406.





## **Chapter 8. The Determination of Nitrite, Nitrate + Nitrite, Orthophosphate and Reactive Silicate in Sea Water using Continuous Flow Analysis**

Updated by: M. Sanderson (April 1997), P. Countway (April 1996); A. Doyle (January 1994)  
Prepared by: J. Sorensen (November 1991)  
Contributions from: C. Garside

### **1.0 Scope and field of application**

This procedure describes the methods for the determination of nitrite, nitrate + nitrite, phosphate and reactive silicate in sea water using Continuous Flow Analysis (CFA). These methods and manifold configurations are suitable for assays of oceanic nutrient levels (e.g. LOD of  $0.005 \mu\text{mol kg}^{-1}$  for nitrite,  $0.03 \mu\text{mol kg}^{-1}$  for nitrate + nitrite,  $0.01 \mu\text{mol kg}^{-1}$  for phosphate and  $0.2 \mu\text{mol kg}^{-1}$  for reactive silicate). Detection ranges are a function of colorimeter calibration settings and sample:dilution volumes used. Therefore, modification of the following methods will allow for expansion or reduction of the detection ranges. Linearity checks should be performed for all methods.

### **2.0 Definition**

The nutrient concentrations of sea water are defined as:

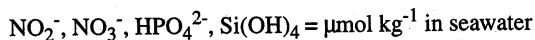

### **3.0 Principle of Analysis**

- 3.1 Continuous Flow Analysis is performed on the Technicon AutoAnalyzer II or equivalent system. By utilizing a continuous mechanically driven stream of samples and reagents, the AutoAnalyzer automates colorimetric analysis, reduces technician error, and allows samples and standards to be treated exactly alike. As the air segmented stream flows through a system of glass coils, the sample-reagent mixture reacts colorimetrically for photometric analysis downstream.
- 3.2 The photometric determination of nitrite and nitrate + nitrite in sea water is based on the reaction of nitrite with an aromatic amine (i.e. sulfanilamide) which results in the formation of a diazonium compound. This is then coupled with a second aromatic amine (i.e. NEDA) to yield a red azo dye. Determination of nitrate + nitrite is accom-

plished with the same procedure as nitrite after the nitrate is reduced to nitrite by passing the sample stream through a column of copperized cadmium.

- 3.3 The photometric determination of phosphate in sea water follows the Technicon Industrial Method No. 155-71WEPA, employing ascorbic acid as the reductant. Ammonium molybdate reacts with phosphate to give phosphomolybdic acid, which is in turn reduced to phosphomolybdous acid, yielding a blue color.
- 3.4 The photometric determination of reactive silicate is based on the formation of a silicomolybdenum blue complex. The sample is reacted with ammonium molybdate in a dilute acid forming silicomolybdic acid which is then reduced to silicomolybdous acid. Stannous chloride is used as the reductant. This method is non-linear at high silicate concentrations and its color yield is sensitive to environmental temperature fluctuations. Reaction coils should be insulated from drafts and the temperature at the reaction coils monitored for change throughout a run.

#### 4.0 Apparatus

Continuous Flow Analysis is performed on the Technicon AutoAnalyzer II or equivalent system. Figures 4 and 5 illustrate the Flow Diagrams (manifolds) for the individual chemistries.

#### 5.0 Reagents

Unless stated otherwise, reagents are stored at room temperature in dark airtight containers and never kept for longer than 1 month.

##### 5.1 Nitrite, Nitrate + Nitrite:

- 5.1.1 *Ammonium Chloride* (Nitrite+Nitrate only): 85.0 g ammonium chloride dissolved in Milli-Q water to a total volume of 1000 ml (8.5% w/v).
- 5.1.2 *Sulfanilamide*: 2.5 g sulfanilamide dissolved in 1.2 N HCl to a total volume of 250 ml (1% w/v).
- 5.1.3 *N-Naphthylethylene-diamine dihydrochloride*: 0.25 g NEDA dissolved in Milli-Q water to a total volume of 250 ml (0.1% w/v).
- 5.1.4 *Cadmium Column* (nitrate + nitrite only):
  - 5.1.4.1 Cadmium filings are washed several times with 1.2 N HCl followed by several Milli-Q water rinses. Filings are then treated with suc-

cessive rinses of 75-100 ml of 2% w/v  $\text{CuSO}_4 \cdot 5\text{H}_2\text{O}$ , each time allowing the blue color of the solution to disappear before decanting and adding fresh solution. Rinses are repeated until the solution remains blue.

- 5.1.4.2 The copper-plated filings are washed with Milli-Q water several times to remove all colloidal copper, until the water above the filings is clear (15-20 rinses are often necessary).
- 5.1.4.3 Filings are then covered with dilute ammonium chloride (~5%  $\text{NH}_4\text{Cl}$ ). They should be kept covered at all times to avoid any further exposure of the Cd-Cu filings to air.
- 5.1.4.4 A small plug of copper thread is inserted at one end of the reduction column. A 50 ml syringe containing dilute ammonium chloride is attached to this end of the column and the column is filled with dilute  $\text{NH}_4\text{Cl}$  to prevent trapping of air bubbles when it is loaded. A small funnel is attached to the end opposite the syringe in order to facilitate loading of the column with the Cd-Cu filings. About 50 g of cadmium filings are required to pack a column. Care is taken on transferring the Cd-Cu filings to the column to avoid extended exposure to air. Small sequential additions of filings are made while drawing on the syringe and tapping the column down. This ensures that the column is evenly and compactly packed. Another small plug of copper thread is inserted when the column is full.
- 5.1.4.5 The column is attached to the two-way valve (see manifold configuration, Figure 4). The column is conditioned by pumping through the  $\text{NH}_4\text{Cl}$  reagent and approximately 50 ml of 100  $\mu\text{M}$  nitrate standard, followed by at least 10 minutes flushing with Milli-Q water. New columns can show an initial rapid increase in reduction efficiency, so additional conditioning may be necessary where high nitrate standards are passed through until a constant efficiency is obtained.
- 5.1.4.6 Columns are stored containing dilute ammonium chloride (~5%). Columns remain effective for hundreds of samples, but are checked for efficiency before and after each run with nitrite and nitrate standards. If air bubbles enter the column the Cd-Cu fillings are removed and the column repacked, as air will lead to rapid oxidation of the copperized cadmium and subsequent nitrate reduction efficiency loss.

## 5.2 Phosphate:

- 5.2.1 *Ammonium Molybdate Stock*: 40 g ammonium molybdate dissolved in Milli-Q water to a total volume of 1000 ml. This reagent is stable for several months if stored in the dark.
- 5.2.2 *Antimony Potassium Tartrate Stock*: 3.0 g antimony potassium tartrate dissolved in Milli-Q water to a total volume of 1000 ml. This reagent is stable.
- 5.2.3 *Ascorbic Acid*: 3.6 g ascorbic acid dissolved in Milli-Q water to a total volume of 200 ml. This solution is made up fresh each day.
- 5.2.4 *Sodium Lauryl Sulfate (SLS)*: 3.0 g SLS dissolved in 100 ml Milli-Q water. SLS serves as a surfactant and can be omitted, though this is not recommended.
- 5.2.5 *Working Reagent A*: a combination of 150 ml sulfuric acid (4.9N), 45 ml ammonium molybdate stock, 15 ml antimony potassium tartrate stock and 6.0 ml SLS. New working reagent is made up daily.
- 5.2.6 *Working Reagent B*: 200 ml ascorbic acid with 1.0 ml SLS. This is made up each day.

## 5.3 Reactive Silicate:

- 5.3.1 *Ammonium Molybdate Stock*: 25 g ammonium molybdate dissolved in Milli-Q water to a total volume of 500 ml. It is stored in a dark bottle in the refrigerator.
- 5.3.2 *Ammonium Molybdate Working Solution*: 100 ml ammonium molybdate stock diluted to 250 ml with 10% v/v HCl. Note: a precipitate forms but redissolves.
- 5.3.3 *Tartaric Acid*: 25 g tartaric acid diluted to a total volume of 250 ml in Milli-Q water.
- 5.3.4 *Stannous Chloride Stock*: 40 g stannous chloride dissolved in 5 N HCl to a total volume of 100 ml. This stock solution is stored in the freezer.
- 5.3.5 *Stannous Chloride Working*: 5 ml of stannous chloride stock solution diluted to 200 ml with 1.2 N HCl. This reagent is very unstable and is replaced daily.

## 6.0 Preparation for sampling

- 6.1 Samples are collected in 60 ml amber bottles (Nalgene® HDPE). Contamination is a major problem with nutrient samples, especially near the surface where the ambient concentrations are low. All the nutrient bottles are rigorously cleaned before use. New bottles are soaked for 2-3 days in 5 % Aquet and tap water, rinsed with tap water, then soaked for 2- 3 days in 10 % HCl. Bottles are then soaked overnight in Milli-Q water and rinsed 5-6 times with Milli-Q water. After bottles have been seasoned they are cleaned between uses by soaking overnight in 5 % detergent, then transferred to 10 % HCl overnight and rinsed 5-6 times with Milli-Q water.
- 6.2 Polycarbonate filter holders (Gelman) are used in the filtering of samples. Cleaning of these begins with an overnight soak in Aquet, followed by tap water rinsing, a soak in 5 % HCl for 1-2 hours and 5-6 rinses with Milli-Q water.

## 7.0 Sampling

- 7.1 Samples are collected at 35 depths between the surface and 4200 m. A filter holder containing a 0.8 µm Nuclepore filter is connected to the OTE bottle. The spigot is opened and two sets of samples (primary and back-up samples) are collected from the water as it filters. Each bottle is rinsed three times and then filled to just below the shoulder. Care is taken to avoid overfilling of samples. Both sample sets are transferred to a freezer (-20°C) and kept frozen until analysis. Five additional samples are collected from one of the two 3000 m and from the 4000 m OTE bottles and frozen. These deep water replicate samples are analyzed during the primary runs to provide additional data points for nutrient concentration variability analysis.

## 8.0 Procedures

- 8.1 Ideally, samples are run within a week of collection. Nutrient analysis is carried out on two separate runs (high and low colorimeter sensitivity settings). Each run has a corresponding set of standard calibration settings in order to maximize sensitivities within each range of expected values.
- 8.2 Sample are thawed in a warm water bath for 10 - 15 minutes, then allowed to equilibrate to room temperature (between 18 and 25°C) and shaken vigorously.
- 8.3 The colorimeters are allowed to warm up for at least 30 minutes while running Milli-Q water through the system and are set at the appropriate standard calibration setting for the run.

- 8.4 Once a stable baseline is established the sample stream is changed to Low Nutrient Sea Water (LNSW) until a new level baseline develops (about 5 min) and then returned to Milli-Q water. This is repeated three times or until two satisfactory baselines are obtained for the two sample streams. The difference between the two baselines constitutes the Refractive Index (RI), which will be used in calculating the blank. The RI test is finished with a baseline of Milli-Q water.
- 8.5 The ammonium chloride reagent is added to the sample stream, and after 5 minutes the CdCu column is opened.
- 8.6 Remaining reagents are added to the sample streams. For silicate analysis, ammonium molybdate is added last, after other reagents have been running for 5 minutes or more. Likewise, ammonium molybdate is removed first when shutting down silicate runs. Failure to do so results in the coating of the flow cell with a dark blue precipitate and requires scrubbing with a dilute NaOH solution.
- 8.7 Once all of the reagents have been added and running for 10 minutes with a good Milli-Q water baseline, the RI test is repeated by alternating between Milli-Q water and LNSW. The difference between the two constitutes both the RI and nutrient concentration of the LNSW (assuming the Milli-Q water is zero) which will be used in calculating the blank. This test is completed with a baseline of LNSW. Seawater blank determination is only necessary for silicate analysis, as nitrate, nitrite and phosphate concentrations in the seawater blank (0.2  $\mu\text{m}$  filtered Sargasso surface seawater) are close to zero.
- 8.8 The Cd column efficiency is checked by running  $10\mu\text{m NO}_3^-$  and  $10\mu\text{mNO}_2^-$  standards at the beginning and end of each run. The values obtained for the two standards are compared, if the efficiency falls below 90% the Cd column must be replaced. Nitrate + nitrite values are corrected for Cd column efficiency.
- 8.9 The autosampler is loaded with the set of standards appropriate for the run type followed by samples. Standards and LNSW baseline checks are re-run after every 15-20 samples. Samples are processed at a rate of 20 per hour.
- 8.10 The run is completed with a long LNSW baseline, followed by a switch to Milli-Q water. At this point the colorimeters are turned off.
- 8.11 All of the reagents are removed except ammonium chloride. With silicate runs, ammonium molybdate is the first reagent removed.

- 8.12 The CdCu column is closed after 10 minutes, and then the ammonium chloride reagent is removed.
- 8.13 The system is washed by running Milli-Q water for 10 minutes, followed by a 5% NaOH solution for 10 minutes, another 10 minutes of Milli-Q water, a 10% HCl wash for 10 minutes and a final rinse with Milli-Q water for at least 10 minutes.

## 9.0 Standardization

- 9.1 Working standards are prepared in aged, filtered (0.2  $\mu\text{m}$ ) LNSW. Standards are prepared using Gilson Pipetman pipettes that are regularly calibrated. Standards for reactive silicate are prepared in Nalgene polypropylene volumetric flasks, while the other nutrient standards are prepared in Class A Pyrex volumetric flasks. Each newly made stock standard is individually checked for potential cross contamination of other nutrients when employing mixed standards.
- 9.2 The LNSW plus reagents baseline (*LR*) is taken as the standard blank since the standards are prepared in LNSW. The Response Factor (*F*) is calculated as follows:

$$F (\mu\text{M chart unit}^{-1}) = \frac{[STD]}{(PH - LR)}$$

Where:

- [STD]* = the concentration of the standard ( $\mu\text{M}$ )  
*PH* = the peak height of the standard (chart units)  
*LR* = baseline of LNSW + reagents

The Response Factor (*F*) applied to the samples is the average of the bracketing standard sets for silicate, nitrite and phosphate runs, while a sample specific *F* is applied to the nitrate+nitrite samples by interpolating between the average *F* at the beginning and the average *F* at the end of the sample set based on sample peak position. The nitrate calculation uses interpolated *F* values to account for cadmium column efficiency loss throughout the course of a run.

## 10.0 Calculations and Blank Determination

10.1 The baseline correction, BLC, applied to the LNSW baseline for each nutrient species is calculated as follows:

$$BLC = LR - (QR + RI)$$

Where:

- LR* = baseline of LNSW + reagents
- QR* = baseline of Milli-Q + reagents
- RI* = refractive index; LNSW baseline - Milli-Q water baseline

10.2 Calculation of the sample blank ( $LR - BLC$ ) assumes that the Milli-Q water baseline plus reagents (*QR*) represents a nutrient concentration of zero. The BLC represents, in chart units, the contribution of the individual nutrients to the LNSW baseline. Generally, we find no detectable levels of nitrate, nitrite or phosphate in our LNSW, but reactive silicate is consistently calculated between 0.7 and 0.8  $\mu\text{M}$  with this method.

10.3 Final nutrient concentrations are calculated using the response factor (*F*) as follows:

$$[\mu\text{M}] = F (PH - (LR - BLC))$$

Where:

- F* = response factor of standards
- PH* = peak height of sample
- LR* = baseline of LNSW + reagents
- BLC* = baseline correction

Note that the baseline LR incorporates a drift correction into all calculations.

10.4 The units of  $\mu\text{moles kg}^{-1}$  are obtained by dividing the calculated nutrient concentrations by the density of the seawater at the time of analysis.



## 11.0 References

- Atlas, E. L., S. W. Hager, L. I. Gordon and P. K. Park. 1971. A practical manual for use of the Technicon Autoanalyzer in seawater nutrient analyses; revised. Technical Report 215. Oregon State University, Dept. of Oceanography, Ref. No. 71-22. 48 pp.
- Chapman, P. and S.A. Mostert. 1990. Does freezing of nutrient samples cause analytical errors? *S. Afr. J. Mar. Sci.* **9**:239-247.
- Gilmartin, M. 1967. Changes in inorganic phosphate concentration occurring during seawater sample storage. *Limnol. Oceanogr.* **12**: 325-328.
- Grasshoff, K., M. Ehrhardt, K. Kremling. 1983. Methods of seawater analysis. 2nd. ref. ed. Verlag Chemie GmbH, Weinheim. 419 pp.
- Hager, S. W., L. I. Gordon and P. K. Park. 1968. A practical manual for use of the Technicon AutoAnalyzer in seawater nutrient analyses. Final report to Bureau of Commercial Fisheries, Contract 14-17-0001-1759. Oregon State University, Dept. of Oceanography, Ref. No. 68-33. 31 pp.
- Kolthoff, I.M., E.B. Sandell, E.J. Meehan and S. Bruckenstein. 1969. Quantitative Chemical Analysis, 4th ed., Macmillan, London. 1199 pp.
- Macdonald, R.W., F.A. McLaughlin and C.S. Wong. 1986. The storage of reactive silicate samples by freezing. *Limnol. Oceanogr.* **31**(5):1139-1142.
- U.S. WOCE Office. 1989. U.S. WOCE Implementation Plan, U.S. WOCE Implementation Report Number 1. College Station, TX. 176 pp.
- Weast, R.C., M.J. Astle and W.H. Beyer, eds. 1985. CRC Handbook of Chemistry and Physics. 66th. edition.

Figure 4. Nitrite and Nitrate + Nitrite Manifold Configuration

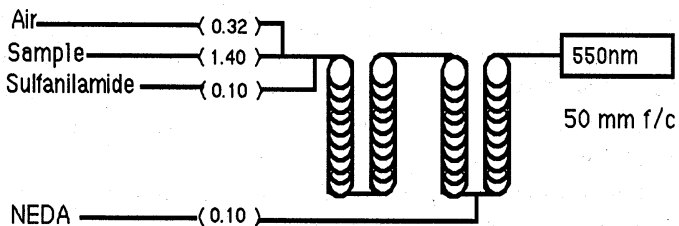

Nitrite Manifold Configuration

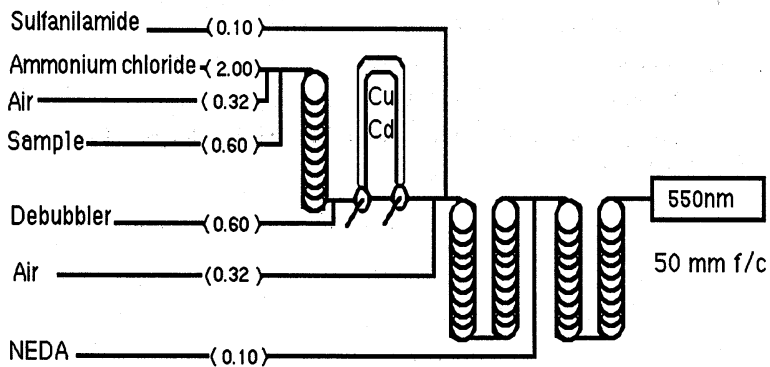

Nitrate + Nitrite Manifold Configuration

Figure 5. Phosphate and Silicate Manifold Configurations

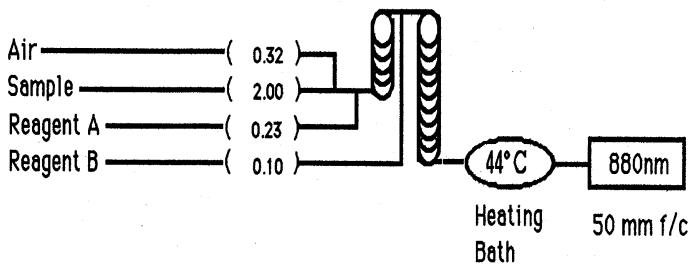

Phosphate Manifold Configuration

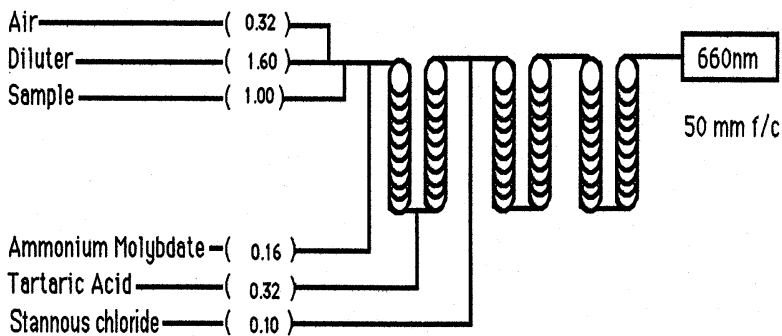

Silicate Manifold Configuration



## **Chapter 9. The Determination of Nitrate in Sea Water**

Updated by: F. Howse (April 1997), A. Doyle (March 1994); A. Michaels, R. Dow and N. Bates (April 1991)  
Prepared by: A. Michaels and R. Dow (October 1989)  
Modified from: Strickland and Parsons (1968)

### **1.0 Scope and field of application**

This procedure describes a method for the determination of reactive nitrate in seawater, suitable for the assay of concentrations between  $0.05 \mu\text{mol l}^{-1}$  to  $45 \mu\text{mol l}^{-1}$ . This method is a modification of Strickland and Parsons (1968).

### **2.0 Definition**

The concentration of reactive nitrate is given in  $\mu\text{mol kg}^{-1}$  in seawater.

### **3.0 Principle of Analysis**

The determination of nitrate is based on the method of Morris and Riley (1963) and modified by Strickland and Parsons (1968). Nitrate is reduced to nitrite using a cadmium-copper column. The nitrite produced reacts with sulfanilamide in an acid solution. The resulting diazonium compound is coupled with N-(1-Naphthyl)-ethylenediamine dihydrochloride to form a colored azo dye, the extinction of which can be measured spectrophotometrically. A correction must be made for any nitrite initially present in the sample.

The following stoichiometric equations apply.

3.1 Nitrate is reduced using a copper-cadmium column:

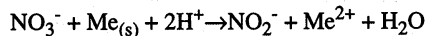

3.2  $\text{NO}_3^-$  can easily be reduced further to NO due to the similar electromotive forces ( $E_0$ ) of the reactions:





- 3.3 To ensure that this does not occur, the reaction takes place in a neutral or slightly alkaline solution.

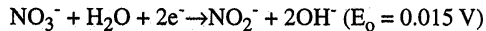

- 3.4 Ammonium chloride in the sample stream acts as both a complexant and as a buffer.

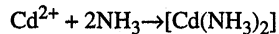

## 4.0 Apparatus

*Spectrophotometer*

## 5.0 Reagents

- 5.1 *Concentrated ammonium chloride solution:* 125 g of reagent grade ammonium chloride ( $\text{NH}_4\text{Cl}$ ) dissolved in 500 ml of Milli-Q water. This solution may be stored in a glass or plastic bottle.
- 5.2 *Dilute ammonium chloride solution:* 50 ml of the concentrated ammonium chloride ( $\text{NH}_4\text{Cl}$ ) solution diluted to 2000 ml with Milli-Q water. This solution may be stored in a glass or plastic bottle.
- 5.3 *Sulfanilamide solution:* 5 g of sulfanilamide dissolved initially in a mixture of 50 ml of concentrated hydrochloric acid and about 300 ml Milli-Q water, then diluted to 500 ml with Milli-Q water. This solution is stable for many months.
- 5.4 *N-(1-Naphthyl) - ethylenediamine dihydrochloride solution:* 0.50 g of the dihydrochloride dissolved in 500 ml Milli-Q water. This solution is stored in a dark bottle and renewed monthly, or sooner if a brown coloration develops.
- 5.5 *Copper sulfate stock solution:* 20 g cupric sulfate pentahydrate,  $\text{CuSO}_4 \cdot 5\text{H}_2\text{O}$  dissolved in 1 liter of Milli-Q water (2% w/v). This is stable at room temperature.

## 6.0 Preparation for sampling

- 6.1 Samples for analysis of both nitrate and nitrite are collected in 250 ml polyethylene bottles. Contamination is a major problem with nutrient samples, especially near the surface where the ambient concentrations are low. All the nutrient bottles are rigorously cleaned before use. New bottles are soaked for 2-3 days in 5 % Aquet and tap water, rinsed with tap water, then soaked for 2 -3 days in 10 % HCl. Bottles are then soaked overnight in Milli-Q water and rinsed 5 -6 times with Milli-Q water. After bottles have been seasoned they are cleaned between uses by soaking overnight in 5 % detergent, transferred to 10 % HCl overnight, and rinsed 5 -6 times with Milli-Q water.
- 6.2 Polycarbonate filter holders (Gelman) are used in the filtering of samples. Cleaning of these begins with an overnight soak in Aquet, followed by tap water rinsing, a soak in 5 % HCl for 1-2 hours, and 5-6 rinses with Milli-Q water.

## 7.0 Sampling

- 7.1 Samples are collected at 35 depths between the surface and 4200 m. A polycarbonate filter holder (Gelman) containing a 0.8  $\mu\text{m}$  Nuclepore filter is connected to the OTE bottle. The spigot is opened and samples are collected from the water that filters. Each bottle is rinsed three times and then filled to just below the shoulder. Care is taken to avoid overflowing of samples. The samples are transferred to a freezer (-20°C) and kept frozen until analysis.
- 7.2 Prolonged storage of samples is avoided.

## 8.0 Procedures

- 8.1 *Cadmium - copper column material:* 100 g of acid-washed cadmium filings are stirred with 500 ml of a 2% (w/v) solution of copper sulphate pentahydrate,  $\text{CuSO}_4 \cdot 5\text{H}_2\text{O}$ , until all blue coloring has left the solution and copper particles enter the supernatant. This material is then used to pack the reduction columns, utilizing a small plug of copper "wool" at each end of the column. About 50 g of cadmium filings are required for a column of about 30 cm long. Columns should have a flow rate of about 10 ml  $\text{min}^{-1}$ . The columns are washed with dilute ammonium chloride solution and the column material completely covered by dilute ammonium chloride solution when not in use.
- 8.2 *Sample analysis*

- 8.2.1 Samples are thawed prior to analysis and should be at a temperature between 15°C and 30°C. Once thawed, analysis should proceed as soon as possible.
- 8.2.2 1.0 ml of concentrated ammonium chloride solution is added to 100 ± 2 ml of sample in a 125 ml Erlenmeyer flask, and the solution mixed
- 8.2.3 Approximately 5 ml of this solution is poured onto the top of the column and allowed to pass through.
- 8.2.4 The remainder of the sample is added to the column and the effluent collected. The first 40 ml or so of effluent is used to rinse the Erlenmeyer flask and a 50 ml graduated cylinder. A further 50 ml of effluent is collected in the graduated cylinder and poured into the flask. Remaining sample is allowed to drain out through the column.
- 8.2.5 There is no need to wash the column in between samples, but if the column is not to be used for over an hour, 50 ml of dilute ammonium chloride should be run through the system. This aids in extending the life of the column.
- 8.2.6 As soon as possible after the reduction, 1.0 ml of sulfanilamide solution is added to the sample in the flask, mixed and allowed to react for between 2 and 8 minutes.
- 8.2.7 1.0 ml of N-(1-Naphthyl)-ethylenediamine dihydrochloride solution is added to the flask and mixed.
- 8.2.8 The extinction of samples at 543 nm is measured between 10 minutes and 2 hours after the addition of the naphthylethylenediamine reagent. Absorbances of less than 0.1 in a 1 cm cell are re-read in a 10 cm cell.

*Reagent Blank Determination:* A reagent blank is barely significant when working with a 1 cm cell but gains considerable importance when a 10 cm cell is used. In either case it is checked throughout each analysis. The reagent blank is determined using Milli-Q water as sample and following the procedure outlined in section 8.2. The concentrated ammonium chloride solution is added to 100 ml of Milli-Q water in a clean Erlenmeyer flask and the column used is flushed with at least 50 ml dilute ammonium chloride solution just prior to use. The absorbance of the blank should not exceed 0.1 using a 10 cm cell.

### 8.3 Standardization



### 8.3.1 Primary nitrate standard:

1.01 g of analytical reagent quality potassium nitrate dissolved in 1000 ml of Milli-Q water; 1 ml = 10  $\mu\text{mol N}$ .

### 8.3.2 Working nitrate standard:

4 ml of primary nitrate standard diluted to 2000 ml with low nutrient seawater (20  $\mu\text{M}$ ). A fresh standard is prepared in a dark bottle each day as needed. Approximately 100 ml of working standard solution is run as described in Section 8.2. Initially, this is performed in triplicate for each column. Thereafter, standards are run with each batch of samples to check the efficiency of the reduction columns.

## 9.0 Calculation and expression of results

9.1 A standardization factor  $F$  can be calculated as:

$$F = \frac{20\mu\text{mol kg}^{-1}}{E_s - E_b}$$

Where:

20  $\mu\text{mol kg}^{-1}$  = concentration of the standard  
 $E_s$  = mean absorbance of the standards  
 $E_b$  = mean absorbance of the blanks

9.2 The nitrate concentration is calculated by:

$$\mu\text{M NO}_3 = \text{corrected absorbance} \cdot F - 0.95C$$

Where:

$F$  = standardization factor  
 $C$  = concentration of nitrite present in the sample  
corrected absorbance = sample absorbance - reagent blank

With good columns, 5% of the nitrite is reduced leading to a correction of 0.95 times the nitrite concentration of the sample is made.

9.3 The units of  $\mu\text{moles kg}^{-1}$  can be obtained by dividing the calculated nitrate concentration by the density of the seawater at the time of analysis.

## 10.0 Notes

- 10.1 *The cadmium-copper column*: The column deactivates through continual use. The addition of the ammonium chloride should slow this process. A well-packed column should be capable of reducing at least 100 samples.
- 10.2 Cadmium that has become inefficient at reduction may be regenerated by washing with 5% (v/v) hydrochloric acid (300 ml for the cadmium from four columns) and rinsing with 300 ml portions of Milli-Q water until the pH of the wash is greater than 5. The cadmium is then re-treated with the copper sulphate solution and re-packed.
- 10.3 Columns should be stored completely covered in dilute ammonium chloride.

## 11.0 References

- Morris and Riley. (1963). *Analytica Chimica Acta*, **29**, 272–279.
- Strickland, J.D.H., and Parsons, T.R. (1968). Determination of reactive nitrate. In: *A Practical Handbook of Seawater Analysis*. Fisheries Research Board of Canada, Bulletin **167**, 71–75.
- Grasshoff, K, M. Ehrhardt, M. and K. Kremling (1983). Determination of nutrients. In: *Methods of Seawater Analysis*. p. 143.

## **Chapter 10. The Determination of Nitrite in Sea Water**

Updated by: F. Howse (April 1997), A. Michaels, R. Dow and N. Bates (May 1991)  
Prepared by: A. Michaels and R. Dow (October 1989)  
Modified from: Strickland and Parsons (1968)

### **1.0 Scope and field of application**

This procedure describes a method for the determination of reactive nitrite in seawater. This method is suitable for the assay of oceanic concentrations between  $0.01 \mu\text{mol l}^{-1}$  to  $2.5 \mu\text{mol l}^{-1}$ . This method is a modification of Strickland and Parsons (1968).

### **2.0 Definition**

The reactive nitrite concentration is given in units of  $\mu\text{mol kg}^{-1}$  in seawater.

### **3.0 Principle of Analysis**

The determination of nitrite is based on the method of Strickland and Parsons (1968). Nitrite reacts with sulfanilamide in an acid solution resulting in a diazonium compound. This is then coupled with *N*-(1-Naphthyl)-ethylenediamine dihydrochloride to form a colored azo dye, the extinction of which can be measured spectrophotometrically.

### **4.0 Apparatus**

*Spectrophotometer*

### **5.0 Reagents**

- 5.1 *Sulfanilamide solution*: 5 g reagent grade sulfanilamide dissolved in a mixture of 50 ml concentrated hydrochloric acid and 300 ml Milli-Q water. This solution is then diluted to 500 ml with Milli-Q water and stored in a glass bottle. It is stable for many months.
- 5.2 *N*-(1-Naphthyl) - ethylenediamine dihydrochloride solution: 0.50 g of the dihydrochloride is dissolved in 500 ml Milli-Q water and stored in a dark bottle. It is replaced monthly or sooner if a brown coloration develops.

## 6.0 Preparation for sampling

- 6.1 Samples are collected in 250 ml polyethylene bottles for analysis of nitrate and nitrite. Contamination is a major problem with nutrient samples, especially near the surface where the ambient concentrations are low. All the nutrient bottles are rigorously cleaned before use. New bottles are soaked for 2 - 3 days in 5 % Aquet and tap water, rinsed with tap water, then soaked for 2 - 3 days in 10 % HCl. Bottles are then soaked overnight in Milli-Q water and rinsed 5 - 6 times with Milli-Q water. After bottles have been seasoned they are cleaned between uses by soaking overnight in 5 % detergent, transferred to 10 % HCl overnight, and rinsed 5 - 6 times with Milli-Q water.
- 6.2 Polycarbonate filter holders (Gelman) are used in the filtering of samples. Cleaning of these begins with an overnight soak in Aquet, followed by tap water rinsing, a soak in 5 % HCl for 1 - 2 hours, and 5 - 6 rinses with Milli-Q water.

## 7.0 Sampling

- 7.1 Samples are collected at 35 depths between the surface and 4200 m. A polycarbonate filter holder (Gelman) containing a 0.8  $\mu\text{m}$  Nuclepore filter is connected to the OTE bottle. The spigot is opened and samples are collected from the filtered water. Each bottle is rinsed three times and then filled to just below the shoulder. Care is taken to avoid overfilling of samples. The samples are transferred to a freezer (- 20°C) and kept frozen until analysed.
- 7.2 Prolonged storage of samples is avoided.

## 8.0 Procedures

### 8.1 *Sample analysis*

- 8.1.1 Samples should be thawed and at a temperature between 15°C and 30°C for analysis. Once thawed, analysis should proceed as soon as possible.
- 8.1.2 The 125 ml Erlenmeyer flasks and 50 ml measuring cylinder to be used in this analysis should be rinsed twice with the sample seawater and shaken dry.
- 8.1.3 50 ml of the sample is measured into a 125 ml Erlenmeyer flask.
- 8.1.4 1.0 ml of the sulfanilamide solution is added to each flask, mixed and allowed to react for 2 - 8 minutes.

- 8.1.5 1.0 ml of the N-(1-Naphthyl) - ethylenediamine dihydrochloride solution is added and mixed immediately.
- 8.1.6 The extinction of the samples at 543 nm is measured between 10 minutes and 2 hours after the addition of the naphthylethylenediamine reagent. Extinctions less than 0.1 in a 1 cm cell should be re-read in a 10 cm cell.

## 8.2 *Reagent blank determination*

- 8.2.1 The reagent blank is determined using Milli-Q water as sample instead of seawater, following the procedure outlined in Section 8.1. This should be done in duplicate. A reagent blank should not exceed 0.03 and should be determined for each batch of samples.

## 8.3 *Standardization*

- 8.3.1 *Primary nitrite standard:* 0.345 g dried anhydrous reagent grade sodium nitrite dissolved in 1000 ml Milli-Q water. 1 ml = 5  $\mu\text{mol}$ . This solution is stored in a dark bottle with 1 ml of chloroform as a preservative and is stable for 1-2 months.
- 8.3.2 *Working nitrite standard:* 10.0 ml of the primary standard solution diluted to 1000 ml with Milli-Q water (1 ml = 0.05  $\mu\text{mol}$ ).
- 8.3.3 *Standard solutions:* Four standard solutions are prepared by diluting 2.0 ml of working nitrite standard up to 50 ml in Milli-Q water. Nitrite determinations of each standard are carried out as described above in Section 8.1.

## 9.0 **Calculation and expression of results**

- 9.1 A standardization factor  $F$  can be calculated as:

$$F = \frac{20 \mu\text{mol kg}^{-1}}{E_s - E_b}$$

Where:

- 20  $\mu\text{mol/kg}$  = concentration of the standard
- $E_s$  = mean absorbance of the standards
- $E_b$  = mean absorbance of the blanks

9.2 The nitrite concentration is calculated by:

$$\mu\text{M NO}_2 = \text{corrected absorbance} \cdot F$$

Where:

$F$  = standardization factor

corrected absorbance = sample absorbance - reagent blank

9.3 The units of  $\mu\text{moles kg}^{-1}$  can be obtained by dividing the calculated nitrite concentration by the density of the seawater at the time of analysis.

## 10.0 References

Strickland, J.D.H., and Parsons, T.R. (1968). Determination of reactive nitrite. In: *A Practical Handbook of Seawater Analysis*. Fisheries Research Board of Canada, Bulletin 167, 71-75.

## Chapter 11. The Determination of Phosphorus in Sea Water

Updated by: K. Elardo (April 1997), A. Michaels, R. Dow and N. Bates (April 1991)  
Prepared by: A. Michaels and R. Dow (October 1989)  
Modified from: Strickland and Parsons (1968)

### 1.0 Scope and field of application

This procedure describes a method for the determination of reactive phosphorus in seawater suitable for the assay of oceanic concentrations of 0.01- 2.5  $\mu\text{mol l}^{-1}$ .

### 2.0 Definition

The reactive phosphate concentration is given in units of  $\mu\text{mol kg}^{-1}$  in seawater.

### 3.0 Principle of Analysis

The determination of reactive phosphorus in seawater is based on the method proposed by Strickland and Parsons (1968). The seawater sample is allowed to react with a composite reagent containing ammonium molybdate, ascorbic acid and potassium antimonyl-tartrate. The resulting complex is reduced *in situ* to give a blue colored solution, the absorbance of which can be measured spectrophotometrically.

### 4.0 Apparatus

*Spectrophotometer*

### 5.0 Reagents

5.1 *Ammonium molybdate solution*: 15 g of reagent grade ammonium paramolybdate,  $(\text{NH}_4)_6\text{Mo}_7\text{O}_{24}\cdot 4\text{H}_2\text{O}$ , dissolved in 500 ml of Milli-Q water. The solution is stable indefinitely if stored out of direct sunlight in a plastic bottle, but if a precipitate forms the solution is discarded.

5.2 *Sulfuric acid solution*: 140 ml of concentrated sulfuric acid added to 900 ml of Milli-Q water. The solution is cooled and stored in a glass bottle.

- 5.3 *Ascorbic acid solution:* 27 g of ascorbic acid dissolved in 500 ml of Milli-Q water. This solution is stored frozen in a plastic container and thawed as needed.
- 5.4 *Potassium antimonyl-tartrate solution:* 0.34 g of potassium antimonyl- tartrate dissolved in 250 ml of Milli-Q water. This solution is stable for many months.
- 5.5 *Mixed reagent:* 100 ml ammonium molybdate solution, 250 ml sulfuric acid solution, 100 ml ascorbic acid solution and 50 ml potassium antimonyl-tartrate solution. The ammonium molybdate is the last reagent to be added. The mixed reagent should have a yellow color and be used preferably at once, or within 6 hours.

## 6.0 Preparation for sampling

- 6.1 Samples are collected in 250 ml polyethylene bottles. Contamination is a major problem with nutrient samples, especially near the surface where the ambient concentrations are low. All the nutrient bottles are rigorously cleaned before use. New bottles are soaked for 2-3 days in 5 % Aquet and tap water, rinsed with tap water, then soaked for 2-3 days in 10 % HCl. Bottles are then soaked overnight in Milli-Q water and rinsed 5-6 times with Milli-Q water. After bottles have been seasoned they are cleaned between uses by soaking overnight in 5 % detergent, transferred to 10 % HCl overnight, and rinsed 5-6 times with Milli-Q water.
- 6.2 Polycarbonate filter holders (Gelman) are used in the filtering of samples. Cleaning of these begins with an overnight soak in Aquet, followed by tap water rinsing, a soak in 5 % HCl for 1-2 hours, and 5-6 rinses with Milli-Q water.

## 7.0 Sampling

- 7.1 Samples are collected at 35 depths between the surface and 4200 m. A polycarbonate filter holder (Gelman) containing a 0.8  $\mu\text{m}$  Nuclepore filter is connected to the OTE bottle with Tygon<sup>®</sup> tubing. The spigot is opened and samples are collected from the filtered water. Each bottle is rinsed three times and then filled to just below the shoulder. Care is taken to avoid overfilling of samples. Samples are transferred to a freezer (-20°C) and kept frozen until analysis.
- 7.2 Prolonged storage of samples is avoided.

## 8.0 Procedures



## 8.1 *Sample analysis*

- 8.1.1 Prior to analysis the samples are thawed and brought to a temperature of between 15° and 30°C. Samples should not sit for long periods of time as the polyethylene bottles may absorb phosphate.
- 8.1.2 100 ml of sample is placed into a 200 ml polyethylene bottle.
- 8.1.3  $10 \pm 0.5$  ml of the mixed reagent is added and immediately mixed.
- 8.1.4 After 5 minutes but within 2 hours, the absorbance of the sample at a wavelength of 885nm is measured in a 10 cm cell, against a blank of Milli-Q water.

## 8.2 *Blank determination*

- 8.2.1 A reagent blank is determined by using Milli-Q water in place of the 100ml seawater sample and carrying out the exact method described in Section 8.1.
- 8.2.2 The reagent blank should not exceed 0.03. If it does, the ammonium molybdate reagent is replaced and the blank determination repeated.

## 8.3 *Standardization*

- 8.3.1 *Primary phosphate standard:* 0.816 g of anhydrous potassium dihydrogen phosphate,  $\text{KH}_2\text{PO}_4$ , dissolved in 1000 ml of Milli-Q water. 1 ml = 6  $\mu\text{mol}$ . This solution is stored in a dark bottle and stable for many months.
- 8.3.2 *Secondary standard:* 10.0 ml of the primary standard solution diluted to 1000 ml with Milli-Q water. 1 ml = 0.06  $\mu\text{mol}$ . The standard is stored in a dark bottle and made fresh every 10 days.
- 8.3.3 A standard solution of 3.0  $\mu\text{M}$  is prepared by diluting 5.0 ml of secondary standard to a volume of 100 ml with Milli-Q water. These standards are run as described in section 8.1.

## 9.0 **Calculation and expression of results**

- 9.1 A standardization factor  $F$  can be calculated as:

$$F = \frac{3.0 \mu\text{mol kg}^{-1}}{E_s - E_b}$$

Where:

- $3.0 \mu\text{mol kg}^{-1}$  = concentration of the standard  
 $E_s$  = mean absorbance of the standards  
 $E_b$  = mean absorbance of the blanks

The reactive phosphate concentration is calculated by:

$$\text{reactive phosphorus } (\mu\text{mol l}^{-1}) = F \cdot \text{corrected absorbance}$$

Where:

- F = standardization factor  
corrected absorbance = sample absorbance - reagent blank

9.2 The units of  $\mu\text{moles kg}^{-1}$  can be obtained by dividing the calculated phosphate concentration by the density of the seawater at the time of analysis.

## 10.0 References

Strickland, J.D.H., and Parsons, T.R. (1968). Determination of reactive phosphorus. In: *A Practical Handbook of Seawater Analysis*. Fisheries Research Board of Canada, Bulletin 167, 49–56.

## **Chapter 12. The Determination of Reactive Silicate in Sea Water**

Updated by: F. Howse (1997), A. Michaels, R. Dow and N. Bates (April 1991)  
Prepared by: A. Michaels and R. Dow (October 1989)  
Modified from: Strickland and Parsons (1968)

### **1.0 Scope and field of application**

This procedure describes a method for the determination of reactive silicate in seawater. This method is suitable for the assay of oceanic concentrations between  $0.1 \mu\text{mol l}^{-1}$  to  $140 \mu\text{mol l}^{-1}$ .

### **2.0 Definition**

The silicate concentration of seawater is given in units of  $\mu\text{mol kg}^{-1}$  in seawater.

### **3.0 Principle of Analysis**

The determination of reactive silicate is based on the method of Strickland and Parson (1968). A seawater sample is allowed to react with ammonium molybdate under conditions which result in the formation of silicomolybdate, phosphomolybdate and arsenomolybdate complexes. A reducing agent of metol and oxalic acid is added and silicomolybdate is reduced to a silicomolybdous acid with a blue color, the absorbance of which is measured spectrophotometrically.

### **4.0 Apparatus**

*Spectrophotometer*

### **5.0 Reagents**

5.1 *Ammonium Molybdate reagent:* 4.0 g of reagent quality ammonium paramolybdate,  $(\text{NH}_4)_6\text{Mo}_7\text{O}_{24} \cdot 4\text{H}_2\text{O}$  is dissolved in 300 ml of Milli-Q water. 12.0 ml of concentrated HCl is added slowly while mixing. Milli-Q water is used to bring the volume up to 500 ml. This solution is stable for many months if stored refrigerated in a polyethylene bottle, but should be discarded if a white precipitate forms.

- 5.2 *Metol-sulphite solution:* 6g of anhydrous sodium sulphite,  $\text{Na}_2\text{SO}_3$ , is dissolved in 500 ml of Milli-Q water, then 10 g of metol (*p*-methylaminophenol solution) is added. When the metol has dissolved, the solution is filtered through No.1 Whatman filter paper and stored in a tightly stoppered glass bottle. This solution should be replaced monthly.
- 5.3 *Oxalic acid solution:* 50 g of reagent grade oxalic acid dihydrate is shaken with 500 ml of Milli-Q water. The solution is stored in a glass bottle and decanted from the crystals for use. It is stable indefinitely.
- 5.4 *Sulfuric acid solution:* 250 ml of concentrated sulfuric acid is diluted to 500 ml with Milli-Q water and cooled. The solution is stored in a glass bottle.
- 5.5 *Reducing reagent:* 100 ml of metol-sulphite solution is mixed with 60 ml of oxalic acid solution. 60 ml of the 50% sulfuric acid solution is added and the solution made up to a volume of 300 ml with Milli-Q water. This reagent should be prepared as needed and used immediately.

## 6.0 Preparation for sampling

- 6.1 Samples are collected in 125ml polyethylene bottles. Contamination is a major problem with nutrient samples, especially near the surface where the ambient concentrations are low. All the nutrient bottles are rigorously cleaned before use. New bottles are soaked for 2-3 days in 5 % Aquet and tap water, rinsed with tap water, then soaked for 2-3 days in 10 % HCl. Bottles are then soaked overnight in Milli-Q water and rinsed 5-6 times with Milli-Q water. After bottles have been seasoned they are cleaned between uses by soaking overnight in 5 % detergent, transferred to 10 % HCl overnight, and rinsed 5-6 times with Milli-Q water.
- 6.2 Polycarbonate filter holders (Gelman) are used in the filtering of samples. Cleaning of these begins with an overnight soak in Aquet, followed by tap water rinsing, a soak in 5 % HCl for 1-2 hours, and 5-6 rinses with Milli-Q water.

## 7.0 Sampling

- 7.1 Samples for analysis of silicate are collected at 35 depths between the surface and 4200 m. A polycarbonate filter holder (Gelman) containing a  $0.8 \mu\text{m}$  Nuclepore filter is connected to the OTE bottle with Tygon<sup>®</sup> tubing. The spigot is opened and samples are collected from the water that passes through the filter. Each bottle is rinsed three times and then filled just below the shoulder. Care must be taken to avoid over-

filling of samples to be frozen. The bottles are transferred to a freezer (- 20°C) and kept frozen until analysed.

7.2 Prolonged storage of samples is avoided.

## 8.0 Procedures

### 8.1 *Sample analysis*

- 8.1.1 Prior to analysis the samples are thawed and brought to a temperature of between 15° and 30°C. Once thawed, analysis should proceed as soon as possible.
- 8.1.2 All glassware should initially be washed in chromic-sulfuric acid and rinsed well with Milli-Q before and after each subsequent use.
- 8.1.3 Sample solutions should be stored at a temperature between 18° and 25°.
- 8.1.4 10 ml of the molybdate reagent is added to a dry 50 ml measuring cylinder fitted with a stopper.
- 8.1.5 25 ml of the sample is pipetted into the cylinder, which is then stoppered. The solutions are mixed and allowed to stand for 10 minutes.
- 8.1.6 The reducing reagent is added and mixed immediately to make the total volume 50 ml.
- 8.1.7 The solution is allowed to stand for 2–3 hours, then the extinction measured at a wavelength of 810 nm.

### 8.2 *Reagent blank determination*

- 8.2.1 The reagent blank is determined using open ocean surface seawater as a sample. The exact procedure outlined in section 8.1 is followed. A reagent blank should not exceed 0.01 on a 1 cm cell or 0.1 on a 10 cm cell and should be determined for each batch of samples.

### 8.3 *Standardization*

- 8.3.1 *Primary silicate standard:* 0.9403g dried  $\text{Na}_2\text{SiF}_6$  is dissolved and made up to 1 liter with Milli-Q water. 1 ml = 5  $\mu\text{mol}$ . It is stored in a dark polypropy-

lene bottle. Ultra pure sodium fluosilicate is difficult to obtain, as with nitrite. It may be advisable to compensate for these impurities.

- 8.3.2 Working standards of concentrations of 50, 25, 10 and 5  $\mu\text{M}$  are prepared by diluting 10 ml, 5 ml, 2 ml and 1 ml of primary silicate standard respectively to 1000 ml in open ocean surface seawater. The exact procedure described in section 8.1 is carried out. These standards should be stored in plastic beakers and used within a few hours.

## 9.0 Calculation and expression of results

### 9.1 Standardization Factor, $F$

- 9.1.1 The absorbance of the reagent blanks is subtracted from the absorbance values of the standards. A linear regression of the silicate concentration and the corrected extinction values is performed. The slope of the line is the standardization factor,  $F$ . The value of  $F$  is typically 100. If a 10 cm cell is used, the  $F$  factor may be assumed to be equal to  $0.1 \times F_{(1 \text{ cm})}$ .
- 9.1.2  $F$  is a function of the salinity of the seawater samples. Between salinities of 25 and 35, the variation may be neglected. The factor  $F_s$  at a salinity of  $S$  is related to  $F$  by:

$$F_s = \frac{F(1 + 0.003S)}{1.08}$$

This correction should be used when the salinity varies more than 10 from a value of 28.

- 9.2 The reactive silicate concentration is calculated by:

reactive silicate ( $\mu\text{mol l}^{-1}$ ) =  $F$  • corrected extinction

Where:

$F$  = standardization factor

Corrected absorbance = sample absorbance - blank absorbance

- 9.3 The units of  $\mu\text{moles kg}^{-1}$  can be obtained by dividing the calculated silicate concentration by the density of the seawater at the time of analysis.

## 10.0 Notes

The silicate and molybdate must combine before the reducing agent is added. Ten minutes is allowed for this reaction. The reducing solution must be added within 30 minutes or else changes in the isomeric form of the silicomolybdate complex will occur.

The sample should be added to the acid molybdate solution instead of the reverse. This prevents unwanted isomeric forms of the silicomolybdate complex.

The time required for the full color development varies with the amount of silicate present in the sample. With a concentration of less than 50  $\mu\text{M}$ , 1 hour is sufficient. For concentrations exceeding 75  $\mu\text{M}$  at least 3 hours should be allowed.

## 11.0 References

Strickland, J.D.H., and Parsons, T.R. (1968). Determination of reactive silicate. In: *A Practical Handbook of Seawater Analysis*. Fisheries Research Board of Canada, Bulletin 167, 65–70.





## **Chapter 13. Measurement of Algal Chlorophylls and Carotenoids by HPLC**

Updated by: C. Rathbun (April 1997), A. Doyle and C. Rathbun (April 1996); A. Doyle (June 1994); T. Waterhouse (February 1993)

Prepared by: J. Sorensen (April 1992)

### **1.0 Scope and field of application**

Many individual algal pigments or pigment combinations and ratios are taxon-specific. Therefore, analysis of the chlorophylls and carotenoids present in a seawater sample can reveal the taxonomic composition of natural algal populations. This technique, using absorbance spectroscopy as analysed by high performance liquid chromatography (HPLC), allows for the rapid separation of phytoplankton pigments with detection limits for chlorophylls and carotenoids on the order of 1 ng (Bidigare, 1991). The HPLC method described here is a modified version of Wright et al. (1991), provided by Bidigare (1991). The method described here has been adopted as BATS protocol since BATS 70 (July 1994). This method uses less solvent than the previously used method and gives improved peak separation and better resolution at lower concentrations.

### **2.0 Definition**

The concentration of all pigments is given as  $\text{ng kg}^{-1}$  in seawater.

### **3.0 Principle of Analysis**

The reverse phase HPLC method described here separates all of the phytoplankton pigments listed in Table 2, in order of polarity upon passage through a column. The most polar pigments are removed earlier than the less polar pigments.

**Table 2. HPLC Pigments.**

Chlorophyllide *a*  
Chlorophyll *c*<sub>3</sub>  
Chlorophyll *c*<sub>1</sub>+ *c*<sub>2</sub> and Chlorophyll Mg 3,8DVP *a*<sub>5</sub>  
Peridinin  
19' - Butanoyloxyfucoxanthin  
Fucoxanthin

19' - Hexanoyloxyfucoxanthin  
Prasincoxanthin  
Diadinoxanthin  
Alloxanthin  
Diatoxanthin  
Lutein  
Zeaxanthin  
Chlorophyll *b*  
Chlorophyll *a*  
 $\alpha$  Carotene  
 $\beta$  Carotene

---

Picoplanktonic prochlorophytes are abundant in tropical and subtropical seas and oceans. They contain divinyl-chlorophyll *a* and divinyl-chlorophyll *b* (more appropriately called 8-desethyl, 8-vinyl Chlorophyll), both of which co-elute with "normal" chlorophyll *a* and *b* with this reverse phase liquid chromatography technique.

#### 4.0 Apparatus

- 4.1 *Filtration System* and Whatman<sup>®</sup> 47 mm GF/F filters
- 4.2 *Liquid nitrogen* and freezer for storage and extraction
- 4.3 *Glass centrifuge tubes* for extraction, 15 ml
- 4.4 High pressure liquid chromatograph capable of delivering three different solvents at a rate of 1 ml/minute.
- 4.5 *High-pressure injector valve* equipped with a 500  $\mu$ l sample loop.
- 4.6 *Column inlet filter* (0.5 $\mu$ m) to protect column from particulates.
- 4.7 *Guard Column* (50 x 4.6 mm, ODS-2 C18 packing material, 5  $\mu$ m particle size) for extending life of primary column.

4.8 *Reverse phase HPLC Column* (250 x 4.6 mm, 5  $\mu$ m particle size, ODS-2 Spherisorb C18 column).

4.9 *Absorbance detector* capable of monitoring at 436 nm.

4.10 *Data recording device*: computer equipped with hardware and software for chromatographic data analysis. (Dyanmax<sup>®</sup> MacIntegrator Version 1.3.1. Rainin Instrument Co. Inc.)

4.11 *Glass syringe*, 1000  $\mu$ l

## 5.0 Eluents

Eluent A (80:20, v:v, methanol: 0.5 M ammonium acetate, aq., pH 7.2).

Eluent B (90:10, v:v, acetonitrile:water).

Eluent C (ethyl acetate).

HPLC-grade solvents are used. Eluents are filtered through a 47 mm GF/F filter and degassed with helium before use.

The gradient program is listed in Table 3.

**Table 3. HPLC solvent system program.**

Time	Flow Rate	%A	%B	%C	Conditions
0.0	1.0	100	0	0	Linear gradient
2.0	1.0	0	100	0	Linear gradient
2.6	1.0	0	90	10	Linear gradient
13.6	1.0	0	65	35	Linear gradient
18.0	1.0	0	31	69	Hold
23.0	1.0	0	31	69	Linear gradient
25.0	1.0	0	100	0	Linear gradient
26.0	1.0	100	0	0	Hold
32.0	1.0	100	0	0	Inject

## 6.0 Sample Collection and Storage

Water samples are collected from OTE bottles into 4 liter polypropylene bottles equipped with a 1/4" outlet and Tygon<sup>®</sup> tubing at the base. Filtration is "in line"; each bottle is connected via the tubing to a polycarbonate filter holder (Gelman) holding a 47mm GF/F

filter, and a vacuum system. Samples are promptly filtered using a vacuum of less than 100 mm Hg. Filters are folded in half and lengthwise in half again, wrapped in aluminum foil and labeled, and stored in liquid nitrogen until on-shore analysis. Alternatively, if analysis is to be carried out onboard ship, filters can be placed in 100% acetone for immediate pigment extraction. Samples collected for HPLC analysis can also be used in the measurement of chlorophyll *a* and phaeopigments by fluorometric analysis.

Filtration volume will vary with sampling location. For oligotrophic waters, 4 liters are filtered, whereas in coastal regions a smaller volume (0.5-1.0 liters) may be appropriate. In this case, a 25 mm GF/F filter is recommended.

## 7.0 Procedure

- 7.1 After removal from liquid nitrogen, the pigments are extracted by placing the filters in 5.0 ml 100% acetone. For 47 mm GF/F filters, approximately 0.8 ml of water is retained on the filter, which adjusts the final extraction solution to approximately 90% acetone and the final extraction volume to 5.8 ml. The samples are covered with Parafilm, sonicated (0°C, subdued light) and allowed to extract overnight in the dark at -20°C. Following extraction, samples are vortexed; then the filters are pressed to the bottom of the tube with a stainless steel spatula and the samples centrifuged for 10 minutes to remove cellular debris.
- 7.2 The addition of 5.0 ml acetone for pigment extraction is necessary to completely submerge 47 mm GF/F filters in 15 ml centrifuge tubes. However, this volume can be altered depending on the sizes of the filter and the extraction tube.
- 7.3 The HPLC system is set up and equilibrated with Solvent System A at a flow rate of 1 ml minute<sup>-1</sup>.
- 7.4 An external standard of chlorophyll *a* is run before each sample set for daily HPLC calibration. An aliquot of 1 ml of standard is mixed with 300 µl of Milli-Q water in a 2 ml vial. Samples are prepared for injection by mixing a 1 ml aliquot of the pigment extract with 400 µl of Milli-Q water in a 2 ml vial. These sub-samples and the standards are shaken and allowed to equilibrate in the dark for 5 minutes prior to injection.
- 7.5 Approximately 1000 µl of sample or standard are injected into the 500 µl sample loop. The three-step solvent program is initiated upon closure of the injection valve. The chromatogram produced is collected on a recording device.

- 7.6 The identities of the peaks from the sample extracts are determined by comparing their retention times with those of pure standards and algal extracts of known pigment composition. Peak identities can be confirmed spectrophotometrically by collecting eluting peaks from the column outlet.
- 7.7 The HPLC system is calibrated with pigment standards obtained commercially and/or by preparative scale HPLC standards (purified HPLC fractions eluted with standard solvents). Concentrations of pigment standards are determined in the appropriate solvent using a monochromator-based spectrophotometer, prior to the calibration of the HPLC system. The recommended extinction coefficients for most of the common algal pigments are provided in Table 4 (Bidigare 1991).

**Table 4: Extinction coefficients of pigments separated by reverse phase HPLC.**

Pigment	Wavelength (solvent)	E 1 cm(l g <sup>-1</sup> cm <sup>-1</sup> )
Chlorophyll <i>a</i>	664 nm (90% acetone)	87.67
Chlorophyll <i>b</i>	647 nm (90% acetone)	51.36
Chlorophyll <i>c</i> <sub>1</sub> + <i>c</i> <sub>2</sub>	631 nm (90% acetone)	42.6
Chlorophyllide <i>a</i>	664 nm (90% acetone)	128.0
Fucoxanthin	449 nm (EtOH)	160.0
19' - Hexanoyloxyfucoxanthin	447 nm (EtOH)	160.0
19' - Butanoyloxyfucoxanthin	446 nm (EtOH)	160.0
Lutein	445 nm (EtOH)	255.0
Zeaxanthin	450 nm (EtOH)	254.0
Prasinoxanthin	454 nm (EtOH)	160.0
Alloxanthin	453 nm (EtOH)	262.0
Peridinin	472 nm (EtOH)	132.5
Diadinoxanthin	446 nm (EtOH)	262.0
Diatoxanthin	449 nm (EtOH)	262.0
β Carotene	453 nm (EtOH)	262.0
Phaeophorbide <i>a</i>	665 nm (90% acetone)	69.8

## 8.0 Standards

- 8.1 Standards stored under nitrogen in the dark at -20°C are stable for approximately one month.

8.2 Pigment standard concentrations are calculated as follows:

$$C_s = \left( \frac{(A_{max} - A_{750nm})}{E \cdot l} \right) \left( \frac{1000mg}{1g} \right)$$

Where:

$C_s$	=	pigment concentration (mg l <sup>-1</sup> )
$A_{max}$	=	absorbance maximum (Table 4)
$A_{750nm}$	=	absorbance at 750 nm to correct for light scattering
$E$	=	extinction coefficient (l g <sup>-1</sup> cm <sup>-1</sup> , Table 4)
$l$	=	cuvette path length (cm)

8.3 After the concentrations of each pigment standard are determined, they are injected onto an equilibrated HPLC system to calculate standard response factors (RF).

The response factors (RF) are calculated as follows:

$$RF = \frac{(C_s)(IV)}{A}$$

Where:

$RF$	=	standard response factor (ng unit area <sup>-1</sup> )
$C_s$	=	pigment standard concentration (ng μl <sup>-1</sup> )
$IV$	=	injection volume (μl)
$A$	=	integrated peak area

## 9.0 Calculation and Expression of results

Concentration of the individual pigments in the sample are calculated using the following formula:

$$C_i = A(RF) \left( \frac{1}{IV} \right) (EV) \left( \frac{1}{SV} \right) (D)$$

Where:

- $C_i$  = individual pigment concentration ( $\text{ng l}^{-1}$ )  
 $A$  = integrated peak area  
 $RF$  = standard response factor ( $\text{ng unit area}^{-1}$ )  
 $IV$  = injection volume (ml)  
 $EV$  = extraction volume (ml)  
 $SV$  = sample filtration volume (l)  
 $D$  = dilution factor

$$D = \frac{\left(\frac{IV}{V_o}\right)}{\left(\frac{IV}{V_s}\right)}$$

Where:

- $IV$  = injection volume of standard or sample ( $\mu\text{l}$ )  
 $V_o$  = Total standard solution volume ( $\mu\text{l}$ )  
 $V_s$  = Total sample solution volume ( $\mu\text{l}$ )

The units of  $\text{ng kg}^{-1}$  can be obtained by dividing the calculated pigment concentrations by the density of the seawater.

## 10.0 References

- Bidigare, R. (1991). in Spencer and Hurd (eds.). The analysis and characterization of marine particles. American Geophysical Union, Washington D.C.
- Herbland, A., A. Le Bouteiller, and P. Raimbault. (1985). Size structure of phytoplankton biomass in the equatorial Atlantic Ocean. *Deep-Sea Res.* **32**:819-836.
- Holm-Hansen, O., and B. Riemann. (1978). Chlorophyll *a* determination: improvements in methodology. *Oikos*, **30**: 438-447.
- Wright, S.W., S.W. Jeffrey, F.C. Mantoura, C.A. Llewellyn, T. Bjørnland, D. Repeta, and N. Welschmeyer (1991). Improved HPLC method for the analysis of chlorophylls and carotenoids from marine phytoplankton. *Mar. Ecol. Prog. Ser.* **77**:183-196.





## **Chapter 14. Measurement of Chlorophyll *a* and Phaeopigments by Fluorometric Analysis**

Updated by: C. Rathbun (April 1997), A. Doyle and C. Rathbun (April 1996)  
Prepared by: J. Sorensen (April 1992)

### **1.0 Scope and field of application**

Chlorophyll *a* measurements have historically provided a useful estimate of algal biomass and its spatial and temporal variability. The fluorometric method is extensively used for the quantitative analysis of chlorophyll *a* and phaeopigments. However, errors can be introduced into the results when chlorophyll *b* and/or chlorophyll *c* are present. Chlorophyll *b* is the main source of error in this method. While generally not abundant in surface waters, chlorophyll *b* can be as high as 0.5 times the chlorophyll *a* concentration in the deep chlorophyll maximum, causing slight underestimations of the chlorophyll *a* concentration, and drastic overestimations of the phaeopigment concentrations. Another source of interference is divinyl-chlorophyll *a*, which is measured as chlorophyll *a* by this method. The procedure described here is appropriate for all levels of chlorophyll *a* concentration in the marine environment. Filtration volumes should be modified for different environments.

### **2.0 Definition**

The concentrations of chlorophyll *a* and phaeopigments in seawater are given as  $\mu\text{g kg}^{-1}$ .

### **3.0 Principle of Analysis**

Some algal pigments, particularly chlorophyll *a*, fluoresce in red wavelengths after extraction in acetone when excited by blue wavelengths of light. The fluorometer excites the extracted sample with a broadband blue light and the resulting red fluorescence is detected by a photomultiplier. The fluorescence of the sample is corrected for phaeopigments by acidifying the sample, which converts all of the chlorophyll *a* to phaeopigments. The fluorescence values before and after acidification can be used to calculate the chlorophyll *a* and phaeopigment concentrations by applying a known conversion ratio.

## 4.0 Apparatus

- 4.1 *Filtration system and Whatman<sup>®</sup> GF/F filters*
- 4.2 *Liquid nitrogen and freezer for storage and extraction*
- 4.3 *Glass centrifuge tubes for extraction, 15 ml*
- 4.4 *Turner fluorometer, fitted with a red sensitive photomultiplier, a blue lamp (GE F4T4-BL), 5-60 blue filter and 2-64 red filter.*

## 5.0 Reagents

- 5.1 *100% acetone*
- 5.2 *90% acetone*
- 5.3 *1.2 M HCl (100 ml HCl in 900 ml Milli-Q water)*

## 6.0 Sample Collection and Storage

Water samples are collected from the OTE bottles into 4 liter polypropylene bottles equipped with a 1/4" outlet and Tygon<sup>®</sup> tubing at the base. Filtration is "in line"; each bottle is connected via the tubing to a polycarbonate filter holder (Gelman) holding a 47mm GF/F filter, and a vacuum system. Samples are filtered promptly using a vacuum of less than 100 mm Hg. Filters are folded in half twice, wrapped in aluminum foil, labeled, and stored in liquid nitrogen until analysis on shore. Alternatively, if analysis is to be carried out onboard ship, filters can be placed immediately into 100 % acetone for pigment extraction.

In oligotrophic waters 4 liters are filtered for this measurement along with HPLC analysis. For fluorometric analysis alone, a smaller volume (0.5 -1.0 l) is sufficient. In coastal regions, a volume of 0.1-0.5 l may be adequate and use of 25 mm GF/F filters appropriate.

## 7.0 Procedure

- 7.1 *After removal from liquid nitrogen (or freezer), the pigments are extracted by placing the filters in 5.0 ml 100% acetone. For 47 mm GF/F filters, approximately 0.8 ml of water is retained, adjusting the final extraction solution to approximately 90 %*

acetone and the final extraction volume to approximately 5.8 ml. The samples are covered with Parafilm, sonicated (0°C, subdued light) and allowed to extract overnight in the dark at -20°C. Following extraction, the samples are vortexed, the filters are pressed to the bottom of the tube with a stainless steel spatula and the samples centrifuged for 10 minutes to remove cellular debris. For fluorometric analysis (not HPLC), decantation can replace centrifuging.

The addition of 5.0 ml acetone for pigment extraction is necessary to completely submerge 47 mm GF/F filters in 15 ml centrifuge tubes. This volume may be altered depending on the size of the filter and volume of the extraction tube.

- 7.2 The fluorometer is allowed to warm up and stabilize for one hour prior to use.
- 7.3 The fluorometer is zeroed with 90% acetone at the start and each time the door setting is changed.
- 7.4 1.0 ml of pigment extract is mixed with 4.0 ml 90% acetone in a cuvette and read on the appropriate door to give a reading between 30 and 90. The sample is then acidified with 2 drops of 1.2 M HCl. Further dilutions may be necessary for higher chlorophyll *a* concentrations.

#### 7.5 *Standardization*

7.5.1 For laboratory use, the fluorometer is calibrated every 6 months with a commercially available chlorophyll *a* standard (*Anacystis nidulans*, Sigma Chemical Company). If the fluorometer is taken to sea, it is recommended that the fluorometer be calibrated before and after each cruise.

7.5.2 The standard is dissolved in 90% acetone for at least 2 hours and its concentration (mg l<sup>-1</sup>) is calculated spectrophotometrically as follows:

$$Chla = \left( \frac{(A_{max} - A_{750nm})}{E \cdot l} \right) \left( \frac{1000mg}{1g} \right)$$

Where:

$A_{max}$  = absorption maximum (664 nm)

$A_{750nm}$  = absorbance at 750 nm to correct for light scattering

$E$  = extinction coefficient for chl *a* in 90% acetone at 664 nm  
(87.67 l g<sup>-1</sup> cm<sup>-1</sup>)

$l$  = cuvette path length (cm)

- 7.5.3 From the standard, a minimum of five dilutions are prepared for each door. Fluorometer readings are taken before and after acidification with 2 drops of 1.2 M HCl.
- 7.5.4 Linear calibration factor ( $K_x$ ) is calculated for each door (x) as the slope of the unacidified fluorometric reading vs. chlorophyll *a* concentration calculated spectrophotometrically.
- 7.5.5 The acidification coefficient ( $F_m$ ) is calculated by averaging the ratio of the unacidified and acidified readings ( $F_o/F_a$ ) of pure chlorophyll *a*.
- 7.5.6 Samples are read using a door setting that produces a dial reading between 30 and 100. The fluorometer is zeroed with 90% acetone each time the door setting is changed.

## 8.0 Calculation and expression of results

The concentrations of chlorophyll *a* and phaeopigments in the sample are calculated using the following equations:

$$\text{Chl } a = \left( \frac{T}{T-1} \right) (Rb - Ra) (Fd) \left( \frac{\text{vol}_{ex}}{\text{vol}_{filt}} \right)$$

$$\text{Phaeo} = \left( \frac{T}{T-1} \right) (T \cdot Ra - Rb) (Fd) \left( \frac{\text{vol}_{ex}}{\text{vol}_{filt}} \right)$$

Where:

- T = acidification coefficient (Rb/Ra) for pure Chl *a* (usually 2.2).  
Rb = reading before acidification  
Ra = reading after acidification  
Fd = door factor from calibration calculations  
vol<sub>ex</sub> = extraction volume (5.8 ml)  
vol<sub>filt</sub> = sample volume (4 l)

- 8.1 The units of  $\mu\text{g kg}^{-1}$  can be obtained by dividing the calculated chlorophyll and phaeopigment concentration by the density of the seawater.

## 9.0 References

- Herbland, A., A. Le Bouteiller, and P. Raimbault. (1985). Size structure of phytoplankton biomass in the equatorial Atlantic Ocean. *Deep-Sea Res.*, **32**: 819-836.
- Holm-Hansen, O., and B. Riemann. (1978). Chlorophyll *a* determination: improvements in methodology. *Oikos*, **30**: 438-447.



## **Chapter 15. Determination of Particulate Organic Carbon and Nitrogen**

Updated by: K. Gundersen (April 1997, August 1992); K. Gundersen, A. Michaels and N. Bates (April 1991)  
Prepared by: K. Gundersen and A. Michaels (October 1989)

### **1.0 Scope and field of application**

This procedure describes a method for the determination of particulate organic carbon and particulate nitrogen in seawater. The assay is appropriate for measuring oceanic levels of particulate organic carbon (5.0 - 500.0  $\mu\text{g C kg}^{-1}$ ) and particulate nitrogen (0.5 - 100.0  $\mu\text{g N kg}^{-1}$ ). The principles for this method were first described by Gordon (1969) and Kerambrun and Szezielida (1969). Sharp (1974) describes a number of useful modifications to the existing method applied here. Detailed description of the analytical procedure is given by the manufacturer (Control Equipment Corporation 1988, Exeter Analytical Inc. 1995).

### **2.0 Definition**

2.1 The concentration of particulate organic carbon is given in  $\mu\text{g C kg}^{-1}$  seawater.

2.2 The concentration of particulate nitrogen is given in  $\mu\text{g N kg}^{-1}$  seawater.

### **3.0 Principle of Analysis**

A dried, acidified sample of particulate matter is combusted at 960°C. The organic carbon is converted to  $\text{CO}_2$  and the nitrogen oxides are subsequently reduced to  $\text{N}_2$  gas. Both gases are measured by thermal conductivity.

### **4.0 Apparatus**

4.1 *Control Equipment Corporation (CEC) 240-XA Elemental Analyzer* (Exeter Analytical, Inc.)

4.2 CAHN Model 4400 Electrobalance

4.3 IBM-PC Compatible Computer Analytical Software

## 5.0 Reagents

5.1 *Hydrochloric acid* (concentrated HCl: reagent grade)

5.2 *Acetanilide* (reagent grade): Acetanilide has 0.7109 g C and 0.1036 g N per gram total mass.

## 6.0 Sampling

Samples are collected at all depths between the surface and 1000 m. The POC/PN samples are taken approximately 30-60 minutes after the CTD/rosette reaches the surface. Samples are collected in 4 liter polypropylene bottles equipped with a 1/4" outlet and tubing at the base. Filtration is "in-line"; each bottle is connected via the tubing to a Delrin filter holder connected to a vacuum system (filtrate-collecting container and pump). Precombusted (450°C, 5 hours) 25 mm Whatman® GF/F filters (nominal pore size 0.7 µm) are mounted in the filter holders. Normally, two liters are filtered at all depths from the surface to 250 m and three liters filtered at depths between 300 and 1000 m, at a vacuum pressure of 100 - 150 mm Hg. This volume may not be adequate for all systems investigated. Filters are placed in acid-washed precombusted (450°C, 5 hours) scintillation vials, capped, and stored in a freezer (-20°C) until processed.

## 7.0 Procedures

### 7.1 *Sample Analysis*

7.1.1 Prior to analysis, the sample vials are uncapped and the filters thawed and allowed to dry overnight at 65°C. The vials are then placed overnight in a desiccator saturated with HCl fumes. The air in the desiccator is saturated due to the presence of concentrated HCl in an open container in the lower compartment of the desiccator. Thereafter, the filters are dried at 65°C and packed in precombusted (900°C, 2 hours) nickel sleeves.

7.1.2 The samples are analyzed on a Control Equipment Corporation (CEC) 240-XA Elemental Analyzer, following the guidelines given by the manufacturer. Sixty-four samples are run at a time on the auto-sampler, of which one is a standard (see below) and approximately nine are nickel sleeve blanks. The machine operator checks on the machine regularly to ensure that problems have not developed. Data are collected and stored automatically by a micro-computer.



7.2 *Standardization and blank determination:* Acetanilide standard and blanks (empty Ni sleeves) are measured prior to each batch run of samples (64 samples). For each set of samples a minimum of three empty filters are processed as an ordinary sample and analysed as filter blanks. The acetanilide standard is weighed in acetone washed tin capsules on a CAHN Electrobalance. Standard weights are usually between 0.25 and 2.0 mg. The tin capsule with the standard is put into a nickel sleeve and run on the Elemental Analyzer. The empty filter blanks are treated exactly like sample filters except that no sample water is passed through them.

## 8.0 Calculation and expression of results

The POC and PN weights of each of the samples are integrated and estimated automatically by the IBM-PC Compatible Computer Analytical Software, supplied with the 240-XA instrument. The program automatically includes the latest Ni sleeve blank into its calculations. The *in-situ* concentrations  $P_C$  (POC) and  $P_N$  (PN) estimated:

$$P_C, P_N (\mu g \cdot kg^{-1}) = \frac{(S - B)}{\left(\frac{V}{1000}\right)^{\rho}}$$

Where:

$S$	=	the result for the filtered sample
$B$	=	the measured filter blank
$V$	=	volume filtered (l)
$r$	=	density (a function of T, S and P, where T = temperature at which sample is taken, S = salinity of the sample, and P = 0)

## 9.0 References

- Control Equipment Corporation. (1988). The automated and advanced Model 240-XA Elemental Analyzer. Lowell, MA.
- Gordon, Jr. D.C. (1969). Examination of methods of particulate organic carbon analysis. *Deep-Sea Research* 16:661-665.
- Kerambrun, P. and K.H. Szekiolda. (1969). Note technique. *Tethys* 1:581-584.
- Sharp, J.H. (1974). Improved analysis for "particulate" organic carbon and nitrogen from seawater. *Limnology and Oceanography* 19:984-989.



## Chapter 16. Determination of Total Organic Carbon by a High Temperature Combustion/Direct Injection Technique

Updated by: R. Parsons (April 1997)  
Prepared by: R. Parsons (April 1996)

### 1.0 Scope and field of application

This protocol describes a high temperature combustion/direct injection (HTC/DI) technique for the determination of total organic carbon (TOC) in seawater, suitable for the assay of concentrations 30-300  $\mu\text{M C}$ .

### 2.0 Definition

The TOC content of seawater is defined as the total concentration of all non-volatile organic substances expressed as  $\mu\text{moles of C kg}^{-1}$  of seawater.

### 3.0 Principle of analysis

This method of analysis is based upon the complete oxidation of organic compounds to carbon dioxide, followed by the quantitative measurement of this  $\text{CO}_2$  by non-dispersive infra-red (NDIR) analysis. This technique was first attempted for seawater by Sharp (1973) upon modification of a procedure developed by Van Hall *et al.* (1963) for fresh water. Interferences from inorganic carbon in seawater are removed by sparging with  $\text{CO}_2$ -free gas after acidification of the sample (Sharp and Peltzer, 1993).

The instrument response is calibrated by the method of standard additions. Known amounts of organic compounds are added to produce a series of solutions with consistently increasing concentrations of organic carbon. The slope of the regression line obtained when peak area is plotted against the amount of carbon added is the instrument response factor. Glucose dissolved in low carbon water (LCW) is used for this calibration. The principle is the same although the calculations are slightly different. (See section 8.3 below).

The instrument blank is determined by injecting a volume of LCW identical to the volume used during sample analysis (100  $\mu\text{l}$ ) and measuring the peak area. This peak area represents the amount of  $\text{CO}_2$  liberated from the catalyst/combustion tube upon injection

of a liquid sample (the system blank) and so each sample injection must be corrected by subtraction of this amount. It is important that the water used for this purpose be as carbon-free as possible (otherwise over-correction will occur and the TOC concentration will be under-estimated) and that this measurement be repeated throughout the analytical sequence to closely monitor the instrument blank, which may vary over time and use. Until a universally available source of carbon free seawater (CFSW) is developed, low carbon water (LCW) is recommended (see section 7.2).

## 4.0 Apparatus

- 4.1 *Sparging apparatus*: After acidification (50  $\mu$ L 85% phosphoric acid: 50mL sample), samples are sparged to remove > 99.95% of the inorganic carbon. Small volume samples (< 40 mL) can be sparged by bubbling CO<sub>2</sub> free gas (oxygen) through a 1/16 inch Teflon line placed directly in the sample to almost the vessel bottom. A flow-rate of 200 ml min<sup>-1</sup> for a minimum of 10 minutes is usually sufficient to remove all inorganic carbon.
- 4.2 *TOC analyzer*: Several versions of HTC/DI analyzers have been built, either commercially or "homemade". Each of these consists of a furnace and gas processing stream containing the following essential components:
- 4.2.1 Source of CO<sub>2</sub>-free carrier gas (medical grade oxygen) delivered through a pressure regulator.
  - 4.2.2 High temperature combustion furnace.
  - 4.2.3 Syringe to inject the seawater sample.
  - 4.2.4 Traps to remove HCl, SO<sub>2</sub> and H<sub>2</sub>O.
  - 4.2.5 Aerosol filter.
  - 4.2.6 NDIR CO<sub>2</sub> analyzer.
  - 4.2.7 Peak area integrator

## 5.0 Reagents

### 5.1 Gases

- 5.1.1 *Oxygen*: Medical Grade Oxygen is used for both the sparge and carrier gas. This grade of gas must be cleaned before use, as it contains hydrocarbons. The gas is passed through 3 quartz tubes (19 x 1/4 inch) packed with platinum

coated alumina beads and heated to 720°C in a high temperature combustion furnace. Three tubes ensure that all hydrocarbons present in the oxygen are combusted to carbon dioxide. The carbon dioxide is removed by passing the gas through an Alltech scrubber packed with soda lime. The gas liberated from this clean-up procedure was referenced against Ultra High Purity oxygen and found to be comparable.

## 5.2 *Dry chemicals*

- 5.2.1 *Ascarite*: Thomas Scientific, Swedesboro, NJ.
- 5.2.2 *Magnesium perchlorate* (anhydrous): Aldrich Chemical Co. Milwaukee WI
- 5.2.3 *Soda lime* (+100 mesh): Aldrich Chemical Co.
- 5.2.4 *Cuprox* (copper oxide): Aldrich Chemical Co.
- 5.2.5 *Copper* (10-40 mesh): Aldrich Chemical Co.
- 5.2.6 *Sulphix* (8-20 mesh): Wako Pure Chemical Industries, Ltd.
- 5.2.7 *Platinum Catalyst* (5/64 alumina ball): Shimadzu
- 5.2.8 *Platinum gauze*: Aldrich Chemical Co.

## 5.3 *Solutions*

- 5.3.1 *85% phosphoric acid (concentrated)* (J.T. Baker Inc. Phillipsburg NJ)
- 5.3.2 Glucose stock solution, 10 mM glucose (Sigma) in LCW.
- 5.3.3 *0.1N hydrochloric acid*: prepared by diluting the concentrated acid (J.T. Baker Inc.) in LCW.

## 6.0 **Sampling**

### 6.1 *Sample bottle preparation*

- 6.1.1 40 ml "EPA vials": Vials are soaked in 10% HCl, rinsed three times with Milli-Q water and air-dried. They are then placed in a muffle furnace at 500°C overnight (12-16 hrs), allowed to cool and capped with cleaned open topped green caps lined with Teflon coated septa. The green caps are cleaned by soaking for at least an hour in Milli-Q, rinsing with more Milli-Q and then

allowing to air dry. The Teflon septa are cleaned separately by soaking in 10% HCl and rinsing with Milli-Q three times.

- 6.2 *Niskin bottles*: "well-aged" OTE/Niskin bottles should be used where possible, with silicone O-rings and either epoxy coated stainless steel springs or heavy-walled silicone tubing. The stopcocks may be nylon, polypropylene or Teflon. The bottles should be free of oil and dirt and rinsed thoroughly with fresh water before the ship leaves port. At a test station or at the first station, the bottles should be well rinsed with seawater. Repeated lowerings and firings at 1-2000 m is recommended.
- 6.3 *Drawing of samples*: TOC samples are easily contaminated with organic compounds adsorbed from the air, from fingerprints or from the sampling ports. In order to keep the sampling ports as clean as possible for these samples, no Tygon<sup>®</sup> or phthalate containing tubing should be used in connection with the sampling ports prior to drawing the TOC samples. Gloves are worn during sampling. TOC samples are drawn early, immediately after the gas samples have been drawn. The sample is allowed to flow freely from the OTE bottle for a few seconds to clean the port. The sample bottle is not allowed any contact with the sampling port. The bottles and caps are rinsed three times with a small volume of sample and then the bottle is immediately filled to about 2/3 volume. Filtering does not take place as POC levels are low ( $< 2 \mu\text{mol C kg}^{-1}$ ) and filtering can result in contamination.

#### 6.4 *Sample storage*

- 6.4.1 *Freezing samples*: The samples are placed in an aluminum block (specifically bored-out to maintain a tight fit with the sample vials) cooled to  $-20^{\circ}\text{C}$  to achieve rapid cooling of the samples. After one hour, the samples are checked to see if they are frozen. Super-cooling often occurs. In this case a quick twist of the vial often encourages immediate solidification of the sample with little or no brine formation. Once frozen, samples are moved to a cardboard container for continued storage at  $-20^{\circ}\text{C}$ . Samples are kept frozen until analysis. Thawing and slow re-freezing of the samples is avoided as this encourages fractionation of the samples and brine formation.

## 7.0 **Procedures**

- 7.1 *Column Preparation*: A quartz tube (19 x 1/2 inch) is used as the combustion tube. It is packed starting from the bottom with cuprox (2 g), sulphix (7 g) and platinum catalyst (10 g) to give a head space of 19 cm. Platinum pillows are placed on top of the packing material and act as the catalyst in the combustion of organic carbon. There is a 10 cm holding tube at the bottom of the tube to ensure that the packing material

stays in place. A column should last 10 days in the lab during analysis of about 150 samples.

7.2 *LCW preparation:* Carbon-free distilled water (LCW) can be prepared by a variety of methods. However, no method is refined to the point that it guarantees a low TOC level. Thus it is imperative that the analyst continually checks the quality of the blank water, maintains quality control charts, and crosschecks with other sources and analysts.

7.2.1 *Milli-Q.* The Milli-Q system is capable of achieving quality LCW. This is verified by comparison against LCW used in Sharpe's community wide comparison. Ampules of Sharpe's LCW are archived and referred against the Milli-Q water. When an acceptable level of Milli-Q water is found, a large volume carboy is taken, acidified and ampulated into 5ml ampules.

7.3 *Standard preparation:*

7.3.1 *Distilled water standards:* A series of reference solutions are prepared by sequential addition of the 10 mM glucose standard stock solution to 100 g of distilled water. 25  $\mu\text{M}$ , 50  $\mu\text{M}$ , 75  $\mu\text{M}$  and 100  $\mu\text{M}$  standards are prepared using LCW in 100 mL volumetrics. 100  $\mu\text{L}$  of 85%  $\text{H}_3\text{PO}_4$  is added to each standard and they are sealed and stored at 4°C. The exact concentration of the standards can be calculated directly from the concentration of the stock solution:

$$\text{DOC}(\mu\text{M C}) = \left( \frac{V_{\text{std}} \cdot C_{\text{stock}}}{100 \text{ ml}} \right)$$

Where:

$V_{\text{std}}$  = volume standard

$C_{\text{stock}}$  = concentration of stock solution

7.4 *Blank determinations:* All peak area measurements are corrected for the instrument blank. In order to do this, a LCW sample is injected at regular intervals throughout the day's analysis run (see section 7.5). Typically, six injections of the blank water sample are made in a 10 minute run. This water is acidified and sparged in the same fashion as the samples.

7.5 *Response factor determination:* There are two ways to determine the instrument response factor. The first involves running the complete set of standard solutions.

Generally, this method is used only when a newly packed column has been placed in the furnace. The second involves running only two standards (high and low) spanning the range of concentrations expected for that days run. Typically, this latter method is used on a day to day basis.

- 7.5.1 *Standard addition series:* After running reference waters (deep seawater and LCW) a standard addition curve is run (3 to 5 injections). For a new column a complete set is run (4 point curve) while for a conditioned column a two point curve is run (100  $\mu\text{M}$  and 25  $\mu\text{M}$ ).
- 7.5.2 *CO<sub>2</sub> gas standard calibration:* Both of the proceeding methods assume that complete oxidation of the added standard is occurring. In order to verify this, one can by-pass the uncertainty of the oxidation step by injecting CO<sub>2</sub> in air standards. These should be obtained from a reliable source (e.g. in the U.S., NIST) with the concentration known to a precision of  $\pm < 1$  ppm. The instrument response is calibrated by injecting (in triplicate) a series of volumes. Mean peak areas are plotted versus moles of CO<sub>2</sub> injected, divided by the nominal injection volume. CO<sub>2</sub> is not an ideal gas so the Van der Waals equation of state must be used to calculate the number of moles injected from the observed volume and room temperature and pressure. The slope of this line should be identical with the normal calibration.
- 7.6 *Analytical protocol:* A typical day's run consists of two runs of both deep reference seawater DRSW and the LCW blank, a calibration set, a series of samples run in groups of 4 to 6 with LCW blanks interdispersed, a LCW blank and a DRSW. The LCW and DRSW samples are run to minimize and stabilize the instrument background/blank. The same sample is run repeatedly so it will be possible to see if the instrument blank has stabilized. The sample is run at least 4 times (more if necessary) in order to obtain a repeatable signal prior to beginning the high-low calibration set.
- 7.7 *Sample injection:* Samples are first sparged with CO<sub>2</sub>-free gas (see section 4.1), then the syringe is filled. First, the syringe is rinsed three times with sample, then over-filled and inverted to expel air bubbles. The excess sample is expressed and 100 $\mu\text{L}$  of the sample is then injected into the furnace.
- 7.8 *Post-Analysis:* Following the sample analysis runs, DRSW and LCW blanks must be run, and finally, the LCW used for the day's run is compared with the long-term standard to check for drift and/or contamination. The data are processed according to the equations in Section 8.



## 8.0 Calculation and Expression of Results

- 8.1 *Peak Screening*: Before calculating the mean corrected peak area for each sample, it is imperative that the peak integration be verified. Peak areas may be rejected, (or re-integrated) where an improper baseline or poor or irregular peak shape is observed, or there are other indications of a bad injection. All acceptable peaks for each sample or blank run are averaged.
- 8.2 *Blank Correction*: Early in the lifetime of the combustion tube, the instrument blank tends to slowly decrease. In these cases, the instrument blank between LCW runs is interpolated with a simple linear interpolation to blank correct the sample runs. Later in the combustion tube lifetime, the instrument blank is usually stable. On these days, the instrument blank is averaged over the course of the days run. Mean corrected peak areas are calculated by subtracting the appropriate instrument blank.
- 8.3 *Response factor determination*
- 8.3.1 *Distilled water standard addition series*: The mean corrected peak area is plotted as a function of the concentration of the distilled water standard and a linear regression is fitted to the points. The slope of the line is the instrument response factor in peak area units per micromole.
- 8.4 *Sample analysis*
- 8.4.1 *Blank determination*: The mean peak area for each of the day's LCW runs (in area units) is calculated provided the LCW has remained stable. If the LCW has drifted by 1-2  $\mu\text{M C}$  over the course of the day, the samples are bracketed and the mean peak area is calculated for that set of samples using the run of LCW before the samples and after the samples. As LCW is injected after every 6 samples, this ensures that any drift in the machine system blank is corrected for. Usually a drift only occurs when a new column is involved.
- 8.4.2 *Zero water adjustment*: The LCW used to make instrument blank measurements throughout the day is  $\sim 3 \mu\text{M C}$ . The TOC concentration of the LCW is measured by comparing it to a "primary standard" of TOC free distilled water which has a TOC concentration of  $\sim 3 \mu\text{M C}$  and has been set aside for this purpose.

8.4.3 *TOC calculation*: The following formula is used to calculate the TOC concentration of a sample in  $\mu\text{moles l}^{-1}$  and the concentration of the DRSW:

$$\text{TOC } (\mu\text{MC}) = \frac{S}{R} - B$$

Where:

- S = average sample area; mean peak area (in mV-secs) for four injections of the sample
- R = response factor; instrument slope as appropriate - either the daily mean or the interpolated value (mV-secs  $\mu\text{MC}^{-1}$ )
- B = average system blank, defined as:

$$\text{Blank} = \frac{\text{LCW}}{R} - 3$$

Where:

- LCW = average sample area for LCW
- R = response factor (as defined above)

8.5 The units of  $\mu\text{mole kg}^{-1}$  can be obtained by dividing the calculated TOC concentration by the density of the seawater at the time of analysis.

## 9.0 Quality control/quality assessment

9.1 *QC charts*: In order to have tight quality control over the analyses, the following are plotted on a daily basis. Instrument drift or bad blanks are readily apparent from any trends in the data.

9.1.1 *Daily blanks* (mean +/- standard deviation in  $\mu\text{M C}$  units) are noted in the machine log book. Deep Reference seawater values are also noted and should be in the range of 43-45  $\mu\text{M}$ .

- 9.1.2 *Daily response factors*: The response factor is noted in the machine log book. This rarely changes. The flow into the column and into the LICOR also are monitored daily and noted in the log book, because alterations in flow will change the response factor.
- 9.2 *Quality assurance*: Although the HTC/DI-TOC analytical method has begun to develop some acceptance within the marine chemical community, it is imperative that each investigator demonstrate the validity of their own analyses. This may be accomplished by comparison with DRSW.
- 9.2.1 *DRSW analysis*: In the absence of a CRM (certified reference material) seawater standard, it is possible to simulate one using DRSW. A large volume (>1 l) sample is collected at from >2000 m. The TOC in this sample should be old and relatively stable and recalcitrant. This material is referenced against previously collected water with a TOC concentration of 43-45  $\mu\text{M}$ . Once the reference concentration is met, this material is acidified, ampulated and used as DRSW. This DRSW is analysed several times a day to monitor the performance of the machine. Any significant drift in the concentration of this seawater indicates a problem with the machine.

## 10.0 Notes

- 10.1 *General precautions*: TOC samples are easily contaminated. Stringent anti-contamination protocols must be adhered to at all times. It is important to observe nearby operations which could adversely affect samples.
- 10.1.1 *Sampling*: No post-analysis mathematical correction can salvage poorly drawn or contaminated samples. Every precaution should be taken to collect samples in the cleanest environment possible. TOC samples should be drawn early to avoid contamination from the tubing used as transfer lines in the collection of most samples, Tygon<sup>®</sup> especially. Any sampling prior to the drawing of TOC samples should use Silicone tubing. Above all, fingers (even when gloved) must be kept out of samples.
- 10.1.2 *Sample storage*: TOC samples are also prone to contamination at this stage. Samples should not be stored in refrigerator/freezers which contain organic material or solvents. For BATS, TOC samples are placed in a dedicated TOC contaminant-free freezer.

## 10.2 Possible modifications:

- 10.2.1 *Blank water*: LCW serves as an adequate instrument blank checking material, however carbon-free seawater is unquestionably superior. Development of a process to produce this material quickly, reliably, easily and cheaply is a priority.
- 10.2.2 *Precision*: Historically, TOC concentrations were regarded as both relatively uniform and invariant, in part, due to the relatively poor precision of the analyses. The uncertainties in these older methods were on the order of 10-25% and detailed information was lost to this imprecision. A much more adequate picture of the oceanic carbon cycle is revealed now that precision of  $\pm 1 \mu\text{M}$ C can be obtained. This level of precision ( $\pm 1-2\%$ ) should be achieved by every analyst.
- 10.2.3 *Deepwater reference*: Deep oceanic concentrations of TOC are relatively low and virtually invariant in time. The deep water TOC serves as a natural CRM for controlling the quality of the TOC analyses. Thus where TOC is measured, samples from  $>2-3000$  m should be analyzed as a check of consistency. On the basis of these analyses, results of the newer analytical techniques can be compared to the historical database.

## 11.0 References

- Benner, R. and M. Strom. (1993). A critical evaluation of the analytical blank associated with DOC measurements by high-temperature catalytic oxidation. In: *Measurement of Dissolved Organic Carbon and Nitrogen in Natural Waters* (eds. Hedges and Lee). **41**(1-3):153-160.
- Gershey, R.M., M.D. MacKinnon, P.J. Le B. Williams and R.M. Moore (1979). Comparison of three oxidation methods used for the analysis of the dissolved organic carbon in seawater. *Mar. Chem.*, **7**:298-306.
- MacKinnon, M.D. (1978). A dry oxidation method for the analysis of the TOC in seawater. *Mar. Chem.* **7**:17-37.
- Sharp, J. (1973). Total organic carbon in seawater—Comparison of measurements using persulfate oxidation and high temperature combustion. *Mar. Chem.*, **1**:211-229.
- Sharp, J. and E.T. Peltzer (1993). Procedures subgroup report. *Mar. Chem.* **41**:37-49
- Sharp *et al.* (1994). Bermuda instrument comparison. *Jour. Mar. Res.*
- Sharp, J.H., R. Benner, L. Bennett, C.A. Carlson, S.E. Fitzwater, E.T. Peltzer and L. Tupas (1995). Dissolved organic carbon: Intercalibration of analyses with Equatorial Pacific samples. *Mar. Chem.* **48**:91-108
- Van Hall, C.E., J. Safranko, and V.A. Stenger (1963). Rapid combustion method for the determination of organic substances in aqueous solution. *Anal. Chem.* **35**:315-319.

Wangersky, P. J. (1975). Measurement of organic carbon in seawater. pp. 148-162, In: *Analytical Methods In Oceanography*, T.R.P. GIBB (ed.), American Chemical Society, Washington, DC.

Wangersky, P. J. (1993). Dissolved organic carbon methods: A critical review. In: *Measurement of Dissolved Organic Carbon and Nitrogen in Natural Waters* (eds. Hedges and Lee). **41**(1-3):61-74.



## **Chapter 17. Determination of Bacterioplankton Abundance**

Updated by: K. Orcutt (April 1997); K. Gundersen, H. Ducklow and A. Close (March 1994)  
Prepared by: H. Ducklow (November 1989)  
Modified from: Hobbie *et al.* (1977), Porter and Feig (1980)

### **1.0 Scope and field of application**

This procedure describes a method for the determination of the abundance of bacteria in seawater using acridine orange or DAPI (4,6-Diamidino-2-phenylindole). The assay is appropriate for measuring oceanic bacterial abundance ( $10^7$ - $10^9$  bacteria  $\text{kg}^{-1}$ ). Both of the common staining techniques are described below. Some scientists use modifications of these techniques. New techniques of flow cytometry are emerging but are not described here. Scientists who employ this or other methods to measure bacterial abundance should make themselves aware of the current and historical issues that surround these techniques and make appropriate decisions about specific methodologies for their application based on the scientific requirements and constraints of their individual programs.

### **2.0 Definition**

Bacterial abundance is given in terms of the number of bacterial cells  $\text{kg}^{-1}$  seawater.

### **3.0 Principle of Analysis**

Bacteria are preserved, stained with either acridine orange or DAPI and concentrated onto a membrane filter. This causes the individual bacteria cells to fluoresce green (using acridine orange) or bluish white (using DAPI) under blue or ultraviolet excitation respectively on an epifluorescence microscope. The individual cells are counted in fields of view of known area and the concentration of bacteria in the original sample is calculated.

### **4.0 Apparatus**

- 4.1 Any high quality epifluorescence microscope equipped with objectives specifically designed for fluorescence work at  $<400\text{nm}$  with immersion oil. The numerical aperture of the objective should be high and the focal plane should be constant across the entire field of vision. Total magnification (objective, eye pieces and auxiliary magnifiers) should be at least 1000x.

- 4.2 A blue filter set (blue excitation 450-490 nm, dichromatic beam splitter 510 nm, barrier filter 520 nm) is used with acridine orange.
- 4.3 An ultraviolet filter set (ultraviolet excitation 365 nm, dichromatic beam splitter 395 nm, barrier filter 420 nm) is used with DAPI.

## 5.0 Reagents

- 5.1 *Glutaraldehyde*: 25%, Grade II (Sigma)
- 5.2 *Acridine Orange*: 80% dye content (Sigma)
- 5.3 *DAPI (4,6-Diamidino-2-phenylindole)*: (Sigma)

## 6.0 Sampling

Samples (90 ml) are measured into a graduated cylinder and then transferred into 125 ml high-density polyethylene bottles. Immediately following collection the samples are preserved in 10 ml of 25% glutaraldehyde and capped and swirled. They are then allowed to stand for 10 minutes at room temperature, after which they are gently swirled and placed in the dark at 4° C for storage. The amount of water to be filtered is a function of expected cell number. Following slide preparation, samples should be examined to ensure the proper number of cells (25-100 per field) (Kirchman *et al.*, 1982) and distribution over the field.

Samples should be processed, stained and filtered as soon as possible (within 2-3 days) after sampling to avoid loss of bacterial numbers (Turley and Hughs, 1992).

## 7.0 Procedures

- 7.1 *Acridine Orange*: A sample volume necessary to yield approximately 100 cells per field of view (total volume > 2 ml) is combined with 0.05% acridine orange (Sigma, 80% dye content) to a final concentration of 0.005% and filtered at <100 mm Hg onto a 0.2 µm, Irgalan Black stained Nuclepore polycarbonate filter (Hobbie *et al.*, 1977). Uniform cell distribution is obtained by prewetting the ground glass base of the filtration apparatus prior to placement of the wet polycarbonate membrane. After filtration, the Nuclepore filter is immediately mounted while still damp on a slide using Resolve brand immersion oil. The stained bacterial cells can be accurately counted up to one year after preparation if the slides are stored frozen and in the dark.



- 7.2 *DAPI*: A sample volume necessary to yield 25-100 cells per field of view (Kirchman et al., 1982) is filtered onto a 0.2  $\mu\text{m}$  Nuclepore filter prestained with Irgalan Black. After filtration, the filter is covered with approximately 1 ml of the DAPI solution (50  $\mu\text{g}/\text{ml}$ ), and left to stain in the dark. Some researchers choose to add 0.3-0.4 ml of a 1 mg/ml DAPI solution to the sample when all but 3-4 ml have filtered. After 3 minutes the DAPI is filtered off and the dry Nuclepore filter is immediately mounted on a slide using Zeiss brand immersion oil 518C ( $n_e=1.518$ ). The stained filters are stored frozen at  $-20^\circ\text{C}$  in sealed slide boxes which are also sealed in zip-lock bags.
- 7.3 Kirchman et al. (1982) recommend a minimum of 7 fields per filter to be counted per sample. Bacteria are distinguished by distinct morphologies which brightly fluoresce; fluorescing images less than 0.2  $\mu\text{m}$  in diameter are disregarded. An eyepiece of known area should be used during enumeration.

## 8.0 Calculation and expression of results:

$$\text{Bacterial Abundance (cells} \cdot \text{l}^{-1}\text{)} = \frac{C_f \cdot R}{F_s}$$

Where:

- $C_f$  = mean number of cells per field  
 $R$  = (active area of filter)/(area of field counted)<sup>2</sup>  
 $F_s$  = volume of water filtered (liters)

- 8.1 The units of  $\text{kg}^{-1}$  can be obtained by dividing the calculated bacterial abundance by the density of the seawater.

## 9.0 Quality control

Accurate measurements of sample filtered and preservative added is important for accurate estimates.

Accurate, repeatable enumeration of bacterial cells by eye requires experience as well as a good microscope. New enumerators should train by counting the same samples as an experienced microscopist until reliable and consistent results are obtained. Periodic

---

<sup>2</sup> Note that the active area of filter through which the water passed is not the outer diameter of the filter. It is equivalent to the inner diameter of the bottom of the filter tower used for that filter.

exchange of samples among different microscopists is useful for maintaining data integrity.

Counts may be calibrated by adding fluorescent microspheres to samples prior to counting. These are available in a variety of sizes, 0.4-2.0  $\mu\text{m}$  and fluorescence properties from Duke Scientific Corporation, Box 50005, Palo Alto, CA 94303 USA; tel 800-334-3883.

There is no absolute standard for bacterial counts. Replicate samples drawn from a single OTE bottle and prepared and counted in parallel should agree to within +/- 15% over the entire range of abundances encountered if the samples are prepared correctly. The precision of the estimate declines if too few or too many cells are concentrated on the filter. See Kirchman *et al* (1982) for a discussion of subsampling and statistical treatments.

## 10.0 References

- Hobbie, J.E., R.J. Daley and S. Jasper. (1977). Use of Nuclepore filters for counting bacteria by fluorescence microscopy. *Appl Environ. Microbiol.* **33**: 1225-1228.
- Kirchman, D.L., J. Sigda, R. Kapuscinski, and R. Mitchell. (1982). Statistical analysis of the direct count method for enumerating bacteria. *Appl. Environ. Microbiol.* **44**:376-382.
- Porter, K.G. and Y.S. Feig. (1980). The use of DAPI for identifying and counting aquatic microflora. *Limnol. Oceanogr.* **25**:943-948.
- Turley, C.M and D.J. Hughes. (1992). Effects of storage on direct estimates of bacterial numbers in preserved seawater samples. *Deep-Sea Res.* **39**: 375-394.

## **Chapter 18. Primary Production**

Updated by: C. Rathbun (April 1997), M. Church and S. Stone (April 1996); A. Close (March 1992); N. Bates (April 1991)

Prepared by: S.E. Lohrenz and M. Tuel (October 1989)

### **1.0 Scope and field of application**

- 1.1 This procedure describes a method for the determination of primary production in seawater, expressed as  $\text{mg C m}^{-3} \text{ day}^{-1}$ . The method is suitable for the assay of all levels of primary production found in the ocean.

### **2.0 Definition**

- 2.1 Primary production is defined as the uptake of inorganic carbon into particulate matter as:

$$\text{Primary production} = \text{mg Carbon m}^{-3} \text{ day}^{-1}$$

### **3.0 Principle of Analysis**

- 3.1 The rate of carbon fixation by autotrophs in seawater is measured by tracing the uptake of radioactive  $^{14}\text{C}$  from the inorganic form to the particulate organic form. Radiocarbon is added at an assumed ratio to the total inorganic carbon content of the seawater sample. The uptake of radiocarbon by the particulate phytoplankton is converted to total carbon uptake by the application of this radiocarbon:total carbon ratio. Inorganic carbon uptake is not measured because samples are acidified before analysis.

### **4.0 Apparatus**

- 4.1 *Packard Tri-Carb 2000CA Liquid Scintillation Analyzer*: Samples in liquid scintillation cocktail are counted for 4 minutes using the following energy window settings:

Channel A: 0.0 - 156 keV

Channel B: 4.0 - 156 keV

An external gamma source is used to assess quenching of individual filter samples for conversion of counts per minute (CPMs) to disintegrations per minute (DPMs). The Packard analyzer uses a proprietary method to mathematically transform the raw Compton spectrum generated in the scintillation cocktail by the external source. This procedure minimizes distortions due to wall and volume dependent effects which can vary from sample to sample. The quench indicating parameter (Qip) is referred to as the transformed spectral index of the external standard (tSIE). The computer-aided liquid scintillation analyzer computes the DPMs during the counting process and provides both CPM and DPM information for each sample. Quenching of the total radioactivity in the vials is determined by an internal standard.

- 4.2 *Incubation Bottles:* Polycarbonate 0.25 l bottles are used for productivity incubations. New bottles are soaked for 72 hours in a 5% solution of Micro detergent. Bottles are then rinsed thoroughly with tap water, and subsequently soaked for 72 hours in the acid cleaning solution (5% HCL). The acid is discarded and the bottles rinsed 3 times with Milli-Q water and then soaked in Milli-Q for at least 48 hours. Once a new bottle has been cleaned as described above, then cleaning between cruises consists of soaking in the acid cleaning solution until approximately 6 hours before use. The bottles are then rinsed and filled with Milli-Q until use.
- 4.3 *250  $\mu$ l Eppendorf Pipet and Tips.* Before use, tips are rinsed two times in acid cleaning solution and four times in Milli-Q water. Cleaned tips are stored in a polyethylene glove until use.
- 4.4 *GoFlo Bottles:* for trace-metal clean sampling. They are acid cleaned every three months.

## 5.0 Reagents

- 5.1 *Stock  $^{14}\text{C}$  sodium bicarbonate* (aqueous, specific activity 2 mCi ml<sup>-1</sup>): purchased from ICN Pharmaceuticals, Inc (Cat.# 17441H).
- 5.2 *Working Solution:* A sodium carbonate (anhydrous, Aldrich # 20, 442-0) solution is prepared by dissolving 0.15 g in 500 ml Milli-Q water in a clean 500ml Teflon bottle. A clean 100ml Teflon bottle for the working solution is rinsed and then filled and soaked with this carbonate solution for 6 hours. The  $^{14}\text{C}$  stock is diluted in the 100ml bottle (1.25 ml stock added to 60 ml of the carbonate solution), giving a final specific

activity of approximately  $41 \mu\text{C ml}^{-1}$ . This working solution is stored refrigerated ( $5^{\circ}\text{C}$ ).

- 5.3 *Acid Cleaning Solution* (0.5 N HCl, Baker Instra-Analyzed): prepared using Milli-Q water.
- 5.4 *Ethanolamine* (Sigma): Used to prevent the radiolabeled inorganic  $\text{CO}_2$  from escaping to the atmosphere.
- 5.5 *Scintillation Cocktail*: Aquasol (Packard Instruments)
- 5.6 *Preparation of Reagents*: Polyethylene gloves are worn during handling of materials which come into contact with isotope solutions. The 100 ml Teflon bottle to hold the working solution is cleaned as described below.

## 6.0 Sampling

### 6.1 Shipboard sampling

- 6.1.1 *Sampling Depths*. A set of 8 standard depths on 20 m intervals from 0 to 140 m are sampled (approximate light levels include 95% – 0.6%).
- 6.1.2 *Hydrocast*. Two hours before dawn, seawater samples are obtained using 12 l Go-Flo bottles deployed on a Kevlar line. The bottom weight on the line is wrapped in plastic. The line is lowered over a plastic polycarbonate-wrapped sheave, and bottles are triggered with brass messengers.
- 6.1.3 *Sampling*. Polyethylene gloves are worn during handling of samples. The productivity bottles are filled directly from the Go-Flos under low light conditions. Bottles are rinsed 3 times before filling. Five bottles are filled for each productivity measurement.
- 6.1.4 *Isotope Inoculation*. Under low light conditions,  $250 \mu\text{l}$  of the  $^{14}\text{C}$  working solution ( $10.25 \mu\text{C}$ ) is added to each bottle using a cleaned polypropylene pipet tip.
- 6.1.5 *Time Zero samples*. A 50 ml aliquot is taken from one bottle from each depth and immediately filtered, as in Section 7.1.
- 6.1.6 *Dark Bottle*. A dark bottle is made by wrapping one of the remaining 4 inoculated bottles in aluminum foil and placing it in a black cloth bag with a velcro closure.

- 6.1.7 *Total Radioactivity.* A 250 $\mu$ l aliquot for counting total added  $^{14}\text{C}$  activity is removed from each of the time-zero bottles and placed in a 20 ml glass scintillation vial containing 250 $\mu$ l ethanolamine (Sigma). The mixture is held at room temperature until subsequent liquid scintillation analysis on shore. This procedure is repeated for an additional aliquot drawn randomly from one of the 3 light bottles from each depth at the end of the incubation period.

## 6.2 *In Situ Incubation Procedures*

- 6.2.1 *Preparation.* The dark bottle and 3 light bottles for each depth are hooked together with a combination of plastic electrical tie wraps and a length of bungi cord. These are kept in dark plastic bags until deployment.
- 6.2.2 *Deployment.* Approximately 1 hour before sunrise, the productivity array is deployed. The bottom weight, attached to a pre-measured polypropylene line, is lowered first. The bungi cords are then secured to hooks attached to the line at each marked depth. The entire productivity line is suspended from an orange plastic float, which is attached to a spar equipped with strobe flash and VHF radio beacon (Novatech). Time and position of deployment is recorded.
- 6.2.3 *Recovery.* Approximately 0.5 hours after sunset, the array is recovered. Sample bottles are detached from the line and placed in dark plastic bags until filtration. Time and position of recovery are recorded.

## 7.0 **Procedures**

### 7.1 *Sample analysis*

- 7.1.1 *Filtration.* Under low light conditions, a 50 ml aliquot is withdrawn from each productivity bottle using a 60 ml plastic syringe. This aliquot is filtered onto a 25 mm Whatman<sup>®</sup> GF/F filter maintaining vacuum levels of 70 mm Hg or less. Neither the filter nor the 50 ml syringe is rinsed. The filter is placed in a 20 ml glass scintillation vial, covered with 250  $\mu$ l 0.5 N HCl, capped, and held at room temperature until subsequent processing on shore.
- 7.1.2 *Filter Processing.* At a shore laboratory, the productivity sample vials are uncapped in a fume hood, and allowed to dry overnight. This procedure ensures complete removal of unfixed inorganic  $^{14}\text{C}$ . Ten ml of liquid scintillation cocktail are added to the dried filters and the samples are shaken vigorously.

7.1.3 *Total Radioactivity Sample.* Ten ml of liquid scintillation cocktail plus 2.5ml of Milli-Q water are added to the vials containing the 250  $\mu$ l sample and 250  $\mu$ l ethanolamine (see above). The mixture is shaken vigorously.

7.1.4 Samples are held at room temperature for 2 days before counting.

## 8.0 Calculation and expression of results

8.1 *Rate Calculations.* DPM values are converted to daily productivity rates using the following equation:

$$\text{Production (mg C m}^{-3} \text{ d}^{-1}) = \left( \frac{SDPM}{V} \right) (W) \left( \frac{0.25 \times 10^{-6}}{TDPM} \right) (1.05) \left( \frac{1}{T} \right)$$

Where:

<i>SDPM</i>	=	DPMs of sample
<i>V</i>	=	volume of sample filtered in liters (usually 0.05 l)
<i>TDPM</i>	=	Total $^{14}\text{C}$ DPMs (250 $\mu$ l)
<i>W</i>	=	25000 mg C m $^{-3}$ (estimated mass of C in seawater)
<i>T</i>	=	Time in days

This calculation is made for each light bottle, and the triplicate values are averaged. A similar calculation is made for time zero and dark bottle samples. The dark bottle rate is subtracted from the mean rate for the light bottles to correct for non-photoautotrophic carbon fixation or adsorption.

8.2 *Integrated Water Column Production.* The individual depth measurements of daily production are used to calculate water column integrated production (mg C m $^{-2}$  d $^{-1}$ ) by trapezoidal integration. The rate nearest the surface is assumed to be constant up to 0 m, and a zero rate is assumed for 200 m.

## 9.0 Quality Control

The measurement of primary production generally has no independent method for calibration. Intercomparison of techniques is also difficult without explicit activities on the same ship or same station. Data are generally evaluated for "reasonableness" in the

context of other core measurements. The coefficient of variation for replicate samples should be  $\leq 10\%$  (Richardson 1991).

## 10.0 Notes

Precaution should be taken to avoid exposure of productivity samples to high light. This is most important for samples collected from deep in the euphotic zone that are photo-adapted to very low light levels. Short-term exposure to high light can both enhance (provide more light for photosynthesis) or degrade (light shock) the photosynthetic performance of the phytoplankton.

Precautionary measures should also be taken to avoid even trace levels of contamination by metals.

## 11.0 References

- Fitzwater, S.E., G.A. Knauer and J.H. Martin (1982) Metal contamination and its effects on primary production measurements. *Limnol. Oceanogr.* **27**: 544-551.
- Joint, I., A. Pomroy, G. Savidge and P. Boyd (1993). Size-fractionated primary productivity in the northeast Atlantic in May-July 1989. *Deep-Sea Res. II* **40**: 423-440.
- Laws, E. A., G.R. DiTullio, P.R. Betzer, D.M. Karl and K.L Carder (1989). Autotrophic production and elemental fluxes at 26°N, 155°W in the North Pacific subtropical gyre. *Deep-Sea Res.* **36**: 103-120.
- Lohrenz, S.E., D.A. Wiesenburg, C.R. Rein, R.A. Arnone, C.T. Taylor, G.A. Knauer and A.H. Knap. (1992). A comparison of in situ and simulated in situ methods for estimating oceanic primary production. *J. Plankton Res.* **14**:201-221.
- Richardson (1991). Comparison of  $^{14}\text{C}$  primary production determinations made by different laboratories. *Mar. Ecol. Prog. Ser.* **72**:189-201.



## **Chapter 19. Determination of Bacterial Production using Methyl-tritiated Thymidine**

Updated by: K. Gundersen (April 1997, September 1992)  
Modified from: Fuhrman & Azam (1980, 1982)

### **1.0 Scope and field of application**

This procedure describes a method for estimating bacterial production in seawater from the incorporation rate of methyl-tritiated-thymidine ( $^3\text{H}$ -thymidine). The technique presented here was first published by Fuhrman and Azam (1980, 1982). Since then, most aspects of the tritiated thymidine incubation technique have been thoroughly investigated. Scientists who employ this or other methods to measure bacterial production should make themselves aware of the current and historical issues that surround these techniques and make appropriate decisions about specific methodologies for their application based on the scientific requirements and constraints of their individual programs.

### **2.0 Definition**

Bacterial production is the rate of synthesis of biomass by heterotrophic bacterioplankton, as estimated by the measurement of incorporated  $^3\text{H}$ -thymidine in the cold trichloroacetic acid-insoluble and cold ethanol-insoluble cell fractions following a short term incubation, using a suitable conversion factor, F:

$$\text{Bacterial production (cells l}^{-1}\text{h}^{-1}) = F \cdot ([^3\text{H-thymidine}] \text{ pmol l}^{-1}\text{h}^{-1})$$

Where:

$$F = \text{production of bacterial cells per mole } ^3\text{H-thymidine}$$

### **3.0 Principle of analysis**

The rate of bacterial production is estimated by tracing the specific incorporation of  $^3\text{H}$ -thymidine into the TCA-insoluble macromolecular fraction. The incubation is terminated by adding formalin, followed by extraction of the unincorporated  $^3\text{H}$ -thymidine from the bacterial cells in cold TCA and ethanol.

### **4.0 Apparatus**

- 4.1 *Hoefer FH 200 Filtration Manifold with stainless steel filtration funnels.* The tritiated incubation solution can be filtered using any reliable, leak-free, acid-resistant, multi-place filtration unit.
- 4.2 *Packard Tri-Carb 2000 CA Liquid Scintillation Analyzer.* Samples in liquid scintillation cocktail are counted on a liquid scintillation analyzer, using the following energy window settings:  
Channel A: 0-19 keV  
Channel B: 2-19 keV
- Samples are counted long enough to reduce the counting error to <5-10%. This is usually obtained within 10 minutes.
- 4.3 *Quench Corrections.* An external gamma source is used to assess quenching of individual filter samples for conversion of counts per minute (CPM) to disintegrations per minute (DPM). Quenching of the total radioactivity vials is determined by an internal standard (usually tritiated water added to a range of concentrations of toluene or chloroform as a quencher).
- 4.4 *Incubation bottles.* Polycarbonate centrifuge tubes (29 ml) are used for the bacterial productivity incubations. Before every cruise, the tubes are soaked in detergent (Aquet<sup>®</sup>), rinsed in Milli-Q water and soaked overnight in a 5% HCl solution. The acid is then discarded and the tubes rinsed and soaked overnight in Milli-Q water.

## 5.0 Reagents

- 5.1 Stock of *methyl-<sup>3</sup>H thymidine* (60-90 Ci mmol<sup>-1</sup>) is commercially available in a 0.1% ethanol solution. It can be stored in this solution if the stock is to be used within 3-4 months. However, if the stock is to be used over a longer period of time, it should be stored in 96% ethanol. Stock solution should be kept in the refrigerator, never frozen.
- 5.2 *Working solution from 0.1 % ethanol solution.* An aliquot of the stock solution is diluted in 0.2 µm filtered Milli-Q water (approximately 1 mCi per 5 ml Milli-Q). Working solution is made no longer than 1-2 days prior to use and is stored in the refrigerator.

*Working solution from 96 % ethanol solution.* An aliquot of the stock solution is transferred to a glass vial where the ethanol is evaporated. The evaporation is promoted by a vacuum pump drawing air through a Silicagel cartridge and a 0.2 µm Nuclepore filter. The tritiated Thymidine is re-dissolved in 0.2 µm filtered Milli-Q

water (approximately 1 mCl per 5 ml Milli-Q) and stored in the refrigerator for not longer than 1-2 days prior to use.

- 5.3 *Acid Cleaning Solution* (1 N HCl, Baker Analyzed) is prepared using Milli-Q water.
- 5.4 Concentrated (37%) *formaldehyde*
- 5.5 *Trichloroacetic Acid* (TCA) is made up in a 5% solution (weight/volume) in Milli-Q water. A pre-mixed 100% TCA solution can also be purchased and diluted to a 5% working solution. The working solution is kept at 4 °C in the refrigerator. Great care should be taken when working with TCA.
- 5.6 *Ethanol* (96%): stored in the refrigerator.
- 5.7 *Ethyl acetate* (Purified, Baker Analyzed)
- 5.8 *Ultima Gold liquid scintillation cocktail* (Packard)

## 6.0 Sampling and incubation

- 6.1 *Shipboard sampling*: A set of 8 standard depths at 20 m intervals from 0-140 m are sampled. Samples are taken from the Primary production Go-Flo cast (see Chapter 18, sections 6.11-6.12.)
- 6.2 *Sample dispensing*. Polyethylene gloves are worn during all stages of sampling and processing. The polycarbonate centrifuge tubes are filled directly from the Go-Flos and rinsed 3 times before filling. Three centrifuge tubes are filled from each depth and stored in the dark until all samples have been taken.
- 6.3 *Time zero* samples. Three additional tubes are filled with 20 ml of sample from each of several depths. 200  $\mu$ l of concentrated (37%) formalin and 50  $\mu$ l of tritiated thymidine working solution are added to the vials prior to sampling, in order to ensure rapid preservation. The solutions are immediately filtered and extracted, as described in section 7.1 of this chapter.
- 6.4 *Isotope inoculation*. Under low light conditions, 100  $\mu$ l of the tritiated thymidine working solution is added to each incubation sample, to a final concentration of about 10 nM.

- 6.5 *Incubation procedures.* Ideally, samples should be incubated at *in situ* temperatures. This can be accomplished using temperature-controlled, refrigerated incubators and/or flowing seawater-cooled incubators. The incubation should last sufficiently long to obtain measurable uptake, but not so long as to cause uptake to depart from linearity. Incubations at the BATS site are usually for 2-3 hours.
- 6.6 *End of Incubation.* The incubation is ended by pouring a 20 ml aliquot from each tube into a separate reagent tube containing 200  $\mu$ l concentrated (37%) formalin. The aliquots are immediately filtered and extracted, as described in section 7.1 of this chapter.

## 7.0 Procedures

- 7.1 *Filtration and extraction.* Under low light conditions, the sample aliquots are filtered onto 25 mm diameter (MFS) cellulose nitrate (0.2  $\mu$ m pore size) filters, maintaining a vacuum pressure of 70 mm Hg or lower. Mixed ester filters should not be used as they bind DNA and result in insufficient counting. The Hoefer filtration manifold is connected via 1/4 inch Tygon<sup>®</sup> tubing to a filtrate collecting container and pump. The reagent tubes are rinsed with 10 ml of an ice-cold 5% TCA solution, followed by a 10 ml rinse with an ice-cold ethanol (96%) solution. After the filter funnel is removed, but with the vacuum pressure maintained, the filters are rinsed three times with ice-cold 5% TCA solution from a wash bottle. The TCA rinses are followed with 3 rinses of ice-cold ethanol from another wash bottle. The wash bottles are kept cold in an ice bucket filled with crushed ice and water during the filtration operation. Care is taken to rinse the outer edges of the filters.
- 7.2 *Filter processing and counting.* The filters are placed in glass scintillation vials. Caps are loosely placed on the vials, and the filters allowed to dry at room temperature overnight. If 7 ml scintillation vials are used, the filters need to be folded carefully 3 or 4 times so they are small enough to permit full immersion in the ethyl acetate. 0.5-1 ml ethyl acetate is added to dissolve the filters. Failure to dry or fully cover the filters in the ethyl acetate solution may result in incomplete dissolution and poor counting efficiency. Vortex mixing is employed to aid in dissolving the filters. Finally, when the filter solution is clear, liquid scintillation cocktail is added and mixed. The samples are counted on a liquid scintillation counter the following day.
- 7.3 *Total Radioactivity Sample.* Aliquots of 50  $\mu$ l from three random incubation tubes are added to a set of three scintillation vials with 10 ml of scintillation cocktail to determine the total amount of label added to the samples.

## 8.0 Calculation and expression of results

*Rate calculations.* Universal factors for conversion of  $^3\text{H}$ -thymidine incorporation into cell production do not exist (Kirchman *et al.* 1982; Ducklow and Carlson 1992) but there is fair consensus that the conversion factor (F) varies in the coastal and open ocean within  $2 \pm 2 \times 10^{18}$  cells  $\text{mol}^{-1}$ . The rate of incorporation is reported as  $\text{pmole } ^3\text{H}$ -thymidine taken up per time unit after time zero blank values are subtracted.

$$[\text{methyl-}^3\text{H-thymidine}] \text{ pmol l}^{-1} \text{ h}^{-1} = \left( \frac{\text{DPM}}{2200} \right) \left( \frac{1000}{V} \right) \left( \frac{1}{\text{SA}} \right) \left( \frac{60}{T} \right)$$

Where:

DPM	=	disintegrations per minute of sample minus blank value
V	=	extraction volume (20 ml)
SA	=	specific activity (of added $^3\text{H}$ -thymidine)
T	=	incubation time (min)

A check on the final concentration of the tritiated incubation solution is estimated by converting the amount of the measured total activity into the final concentration of tritiated thymidine.

$$[\text{methyl-}^3\text{H-thymidine}] \text{ nM} = \left( \frac{\text{DPM}}{2200} \right) \left( \frac{1000}{\mu\text{l}} \right) \left( \frac{1}{\text{SA}} \right)$$

Where:

$\mu\text{l}$	=	aliquot taken from incubation solution (50 $\mu\text{l}$ )
SA	=	specific activity

## 9.0 Quality Control

- 9.1 *Standards and precision.* There is no absolute standard for bacterial production measurements and the accuracy is unknown. The coefficient of variation of assays performed carefully following this protocol should be 15-20% for triplicate incubations. The limit of detection will vary depending on length of incubation and the amount of sample filtered. With care, incorporation rates of  $0.05\text{-}0.1 \text{ pmol l}^{-1} \text{ h}^{-1}$  should easily be detected above background.

9.2 *Non-specific incorporation of thymidine.* Much of the uncertainty with thymidine results appears due to non-specific labelling. Tritiated thymidine does not exclusively enter the bacterial DNA and several studies have demonstrated the labelling of macromolecular compounds other than DNA (Hollibaugh 1988).

Non-specific labelling makes it very important to use an extraction procedure specific for tritiated DNA (Wicks and Robarts 1987, Hollibaugh 1988, Robarts and Wicks 1989). New techniques using enzymatic digestion (Torreton and Bouvy 1991) also look promising.

## 10.0 Interpretation of results

A conversion factor is needed to derive bacterial production (cells or mass of C or N produced per unit time) from the incorporation rates. Conversion factors should ideally be determined experimentally for each new environment or season sampled. To determine a conversion factor, an independent measurement of bacterial production or growth rate must be made, or the relationship between thymidine incorporation and production must be determined. A variety of approaches exist for this purpose (Bjørnsen and Kuparinen, 1991; Ducklow et al., 1992; Kirchman and Ducklow, 1993). For open ocean sites the conversion factor is generally  $2 \times 10^{18}$  cells produced per mole thymidine incorporated.

## 11.0 References

- Bjørnsen, P.K., and J. Kuparinen (1991). Determination of bacterioplankton biomass, net production and growth efficiency in the Southern Ocean. *Mar. Ecol. Prog. Ser.* **71**:185-194.
- Carman, K.R., F.C. Dobbs and J.B. Guckert. (1988). Consequences of thymidine catabolism for estimates of bacterial production: An example from a coastal marine sediment. *Limnol. Oceanogr.* **33**:1595-1606.
- Ducklow, H.W. and C.A. Carlson. 1992. Oceanic Bacterial Production. *Advances in Microbial Ecology*. K.C. Marshall ed. p. 113-181. Plenum Press.
- Ducklow, H.W., D.L. Kirchman and H.L. Quinby. (1992). Bacterioplankton cell growth and macromolecular synthesis in seawater cultures during the North Atlantic spring phytoplankton bloom, May 1989. *Microb. Ecol.* **24**:125-144.
- Fuhrman, J.A. and F. Azam. (1980). Bacterioplankton secondary production estimates for coastal waters of British Columbia, Antarctica and California. *Appl. Environ. Microbiol.* **39**:1085-1095.
- Fuhrman, J.A. and F. Azam. (1982). Thymidine incorporation as a measure of heterotrophic bacterial production in marine surface waters: evaluation and field results. *Mar. Biol.* **73**:79-89.

- Hollibaugh, J.T. (1988). Limitations of the [ $^3\text{H}$ ]thymidine method for estimating bacterial productivity due to thymidine metabolism. *Mar. Ecol. Prog. Ser.* **43**:19-30.
- Kirchman, D., H. Ducklow and R. Mitchell. (1982). Estimates of bacterial growth from changes in uptake rates and biomass. *Appl. Environ. Microb.* **44**:1296-1307.
- Robarts, R.D. and R.J. Wicks. (1989). Methyl- $^3\text{H}$  thymidine macromolecular incorporation and lipid labeling: their significance to DNA labeling during measurements of aquatic bacterial growth. *Limnol. Oceanogr.* **34**:213-222.
- Torretón, J.P. and M. Bouvy. (1991). Estimating bacterial DNA synthesis from [ $^3\text{H}$ ]thymidine incorporation: Discrepancies among macromolecular extraction procedures. *Limnol. Oceanogr.* **36**:299-306.
- Wicks, R.J. and R.D. Robarts. (1987). The extraction and purification of DNA labelled with methyl- $^3\text{H}$  thymidine in aquatic bacterial production studies. *J. Plank. Res.* **9**:1159-1166.





## Chapter 20. Trap-Collected Particle Flux with Surface-Tethered Traps

Updated by: K. Gundersen (April 1997, September 1992); N. Bates (April 1991)  
Prepared by: M. Tuel and S.E. Lohrenz (October 1989)

### 1.0 Scope and field of application

This procedure describes a method for the determination of the sinking fluxes of particulate matter and particulate carbon and nitrogen in seawater, expressed as  $\text{mg m}^{-2}\text{day}^{-1}$ . The method is suitable for the assay of all levels of sinking flux found in the ocean. This method was developed by Knauer *et al.* (1979) and used extensively in the VERTEX program. As described here, this method does not conform to all of the recommendations of the U.S. JGOFS Planning Report #10 on sediment trap sampling and technology. It is presented as an example of a widely-used technique. There is no consensus in the JGOFS community on the appropriate methods for trapping.

Sediment traps are the only tool for directly collecting the rain of sinking particles in the ocean. They are largely uncalibrated in the field and there are significant unresolved questions on the accuracy and precision of sediment traps. Any investigators that decides to use sediment traps should become aware of all facets of this controversy and make their own decisions about the appropriate methods to use. The U.S. JGOFS Planning Report #10 provides an overview of these issues and there have been significant published papers on trap accuracy since that report.

### 2.0 Definition

- 2.1 *Total particulate mass flux* is defined as the amount of sinking particulate matter passing through a depth level as:

$$\text{Total Mass Flux} = \text{mg dry weight m}^{-2} \text{ day}^{-1}$$

- 2.2 *Total particulate carbon flux* is defined as the amount of sinking particulate organic carbon passing through a depth level as:

$$\text{Total Organic Carbon Flux} = \text{mg carbon m}^{-2} \text{ day}^{-1}$$

- 2.3 *Total nitrogen mass flux* is defined as the amount of sinking particulate organic nitrogen passing through a depth level as:

$$\text{Total Organic Nitrogen Flux} = \text{mg nitrogen m}^{-2}\text{day}^{-1}$$

### 3.0 Principle of Analysis

Fluxes of sinking material are measured using sediment traps (Knauer *et al.* 1979). In the BATS program, these are simple cylinders suspended at various depths from surface and subsurface floats. These cylinders collect sinking particles. It is assumed that the collection of particles is linearly related to the aperture area of the sediment trap and that this collection is an accurate estimate of the mass of sinking particles at that depth and the particle sinking speeds. Hydrodynamic and other biases influence the collection of material by sediment traps and the interpretation of trap data should be approached with caution.

### 4.0 Apparatus

The design of the array used in the BATS program is shown in Figure 6.

- 4.1 *Particle Interceptor Traps (PITs)*. The particle collection device central to the Multi-traps is a polycarbonate cylinder (cross-sectional collection area =  $0.0039 \text{ m}^2$ ). The cylinder is equipped with a base which holds a 90 mm Poretics polycarbonate membrane filter. A drain valve is mounted under the base of the filter holder. At the surface of the cylinder, plastic baffling consisting of circular openings 1.2 cm in diameter provide turbulence reduction at the trap opening.
- 4.2 *PITs Frame*. A cylindrical stainless steel PITs rack (1 m in diameter) allows for mounting of up to 15 sediment trap cylinders at each depth. The stainless steel frame is attached to the 1/2 inch polypropylene line by stainless steel shackles. The prepared PIT cylinders are held in place on the stainless steel frame by hoseclamps that are protected with Tygon<sup>®</sup> tubing. Stainless frames with PITs are attached at 3 depths: 150, 200 and 300 meters.
- 4.3 *Flotation Gear*. At 90 m depth, a polypropylene line is attached to a stainless swivel, which is attached to a stainless steel chain with two 17 inch diameter glass floatation spheres covered by a polyethylene "hard hat" housing. At the surface the polypropylene line is attached to a 10 m double length of 1/2 inch bungie cord connected to a 5/8 inch double braided Duralon line with 8 orange polypropylene A2 floats. The entire flotation array is secured to a surface spar.

- 4.4 *Surface Spar.* The surface spar consists of a styrofoam core float with a central mast on which is mounted a VHF radio beacon (Novatech), strobelight (Novatech), and ARGOS transmitter.
- 4.5 *Current Meter.* At BATS we usually deploy an Aanderaa RCM-current meter at 160 m depth. This instrument records time, pressure, temperature, flow speed and flow direction. It records a vector average flow speed and direction at one minute intervals and records the instantaneous measurements every minute for the other parameters. In previous experiments we have deployed a custom-built hydrodynamic sensing package (HDS) that uses microsensing flowmeters based on the hot-wire principle. These packages record flow at four locations on the trap array at 5 Hz plus a variety of other hydrographic parameters (Gust *et al.*, 1994)

## 5.0 Reagents

- 5.1 *Hydrochloric acid* (12N, Baker Instra-Analyzed): diluted to make cleaning solutions.
- 5.2 *Formalin* (reagent grade)
- 5.3 *Sodium chloride* (reagent grade)
- 5.4 *Density Gradient Solution.* A density gradient solution is used to reduce advective-diffusive exchange of trap contents with ambient seawater during deployment. The density gradient solution is prepared by adding 1 l formalin and 2.5 kg NaCl to 50 l seawater, yielding a 2% formalin and approximately  $86 \text{ g l}^{-1}$  NaCl solution. The solution is gravity filtered through a  $0.5 \mu\text{m}$  cartridge membrane filter (Millipore) and used to fill the PITs prior to deployment. A one liter portion of this gradient is saved for subsequent processing steps (see below).

## 6.0 Sampling

- 6.1 *Pre-sampling preparation:*
- 6.1.1 *Filter Preparation.* Poretics polycarbonate membrane filters (90 mm diameter,  $0.8 \mu\text{m}$  pore size) are soaked overnight in 1.2N HCl (Baker Instra-Analyzed), rinsed with further 1.2 N HCl, rinsed three times with Milli-Q water and placed in individual plastic petri dishes. The cleaned filters are oven dried ( $65^\circ \text{C}$  for a couple of days), allowed to cool in a desiccator, and tared to constant weight on an analytical balance (Sartorius R160P).

6.1.2 *Trap Cleaning Procedure.* The porous polyethylene filter frit is rinsed in Milli-Q, soaked for 24 hours in 1.2 N HCl, and rinsed with Milli-Q three times. All other trap parts are soaked overnight in a dilute Aquet Manostat detergent solution, rinsed thoroughly in tap water to remove the detergent, soaked 24 hours in 0.6 N HCl, and then rinsed in Milli-Q. The PITs are assembled while wearing latex gloves. The prepared Poretics filters are attached to the base of the polycarbonate cylinders together with the porous filter frit and covered by the filter holder with the drain valve. Polyethylene tape is used to provide a seal between the filter holder to the cylinder. The assembled PITs are stored covered with red polyethylene caps.

## 6.2 *Deployment and Recovery:*

6.2.1 *Deployment.* Prior to deployment, the PITs are filled with density gradient solution and mounted on the frames. Three PITs are mounted on each of three frames, which are deployed at 150, 200 and 300 m. Polyethylene caps are kept on the PITs until each frame is attached to the line and about to be submerged.

The trap array is deployed for a minimum of 72 hours. Generally the array is deployed as the first cruise procedure (see Chapter 2). The location of the trap is checked periodically during the deployment.

6.2.2 *Recovery.* The traps are covered with red polyethylene caps before they are removed from the frame. The seawater at the top of the trap is siphoned off to just above the level of the visible density interface using acid-rinsed (0.6 N HCl) rigid Teflon<sup>®</sup> tubing. The density gradient solution is drained through the bottom of the trap and discarded. The Poretics filter is removed, returned to its petri dish, sealed with Parafilm and labeled. The filters are stored in the refrigerator until analyzed.

## 7.0 **Sample Processing Procedures**

7.1 *Picking Swimmers.* The “swimmers” (recognizable zooplankton) are removed using forceps under a dissecting microscope (12–50 power magnification). The filters are kept wet during this period by adding small volumes of the saved density gradient solution (see above). The zooplankton (down to less than 100  $\mu\text{m}$  in size) are removed with very fine-tipped forceps and placed into small vials with some of the reserve trap preservative. The vial contents can later be used to assess the effectiveness of swimmer removal (see Section 9.2). Manual removal of swimmers is a time-consuming process and still may leave significant swimmer material behind (e.g. see Michaels *et al.*, 1990). It is however superior to screening or other indirect methods.

Screening can remove very large passively sinking particles, but will not remove swimmers that are smaller than the mesh.

Manual picking of swimmers is a subjective exercise. Some labs remove only the largest zooplankton and some attempt to pick the samples at sea where the ship motion can reduce the ability to discern the smaller zooplankton. As there is no absolute standard to compare sediment traps with, there is no absolute way to determine the effectiveness of the swimmer removal by any lab. In the BATS deployments, it generally takes 4-12 hours to remove the swimmers from each PIT tube after a three day deployment in this oligotrophic regime (see Section 9.2 for additional techniques to assess the swimmer problem).

7.2 *Mass Flux.* The material on the filter is scraped into a bolus at the center of the filter with a scalpel and salts are removed by rinsing with Milli-Q water adjusted to pH 9 with ammonium hydroxide. The filter with the sample bolus is oven dried (65 °C), placed in a dessicator and weighed daily until the weight is constant ( $\pm 0.01$ mg) for 2 consecutive weighings.

7.3 *Particulate Carbon and Nitrogen Analysis.* Carbon and nitrogen analyses are performed using a Control Equipment Corporation (CEC) 240 XA elemental analyzer calibrated with acetanilide. The bolus is scraped off the filter with a scalpel and ground in an agate mortar. The whole sample (50-300  $\mu$ g) is transferred to a silver boat and weighed on a CAHN Electrobalance (Model 4400). The silver boats are put in wells drilled in a Teflon block, and fumed with concentrated HCl for 36 hours to volatilize inorganic carbon. The fumed boats are desiccated overnight and then analyzed for total nitrogen and organic carbon. The results from the CHN analysis yield %C and %N.

## 8.0 Calculation and expression of results.

8.1 *Mass flux.* The mass flux is calculated as follows: The mass weight minus the tare weight of the filter divided by the number of days deployed and the by the trap cross-sectional area (0.0039  $m^2$ ) equals the mass flux ( $mg\ m^{-2}\ d^{-1}$ ).

$$\text{Mass flux } (mg\ m^{-2}\ day^{-1}) = \frac{(M_w - F_w)}{D \cdot A}$$

Where:

$M_w$	=	mass weight
$F_w$	=	filter weight
$D$	=	days deployed
$A$	=	trap area

- 8.2 *Particle flux.* CHN analysis yields the %C and %N determinants. Particulate flux (mg N or mg C m<sup>-2</sup> d<sup>-1</sup>) is then calculated by multiplying the %C or %N by the mass flux.

$$\text{Particle flux (mg C or mg N)} = \text{Mass flux} \times \%C \text{ (or \%N)}$$

## 9.0 Quality Control and Assessment

- 9.1 *Hydrodynamics.* Although there are few field data, published reports indicate that flows above 15 cm s<sup>-1</sup> at the trap mouth probably cause biases in trap collection. There is a large but insufficient literature on trap hydrodynamics (see U.S.JGOFS Planning Report # 10, Gust *et al.*, 1994).
- 9.2 *Swimmers.* The effectiveness of swimmer removal can be determined by examining a replicate PIT sample (different tube) with a different technique. The swimmer tube(s) should be deployed in the same way as the mass flux tubes. On recovery, the entire tube contents (after siphoning the upper, exchanged solution) should be transferred to a sample bottle (approximately one liter of liquid). This solution should be allowed to settle for a few days, then the supernatant gently siphoned off. By repeating this process, the sample can be gently concentrated down to a manageable volume (size will depend on the amount of material). This sample can then be counted in much the same way as a plankton tow. The numbers and sizes (values that can be converted to biovolumes or carbon units) of zooplankton can be counted on both a dissecting microscope and an inverted compound microscope using quantitative techniques. The picked swimmers from each of the mass flux traps can then be counted with the same techniques (they are saved after removal from the filters). By comparing the zooplankton in the complete sample(s) with the zooplankton actually removed, the biovolume of unremoved zooplankton can be calculated. Some zooplankton from each of the dominant unremoved swimmer taxa should then be measured for biovolume and carbon content to create a conversion factor for relating the unpicked biovolume to the total measured carbon. This allows a first-order correction for the residual swimmer problem. In practice it is often of similar magnitude as the passive flux in shallow traps (Michaels *et al.*, 1990).

## 10.0 References and Related Literature

- Baker, E. T., Milburn, H. B. and Tennant, D. A. (1988). Field assessment of sediment trap efficiency under varying flow conditions. *J. Mar. Res.* **46**: 573-592.
- Coale, K. H. (1990). Labyrinth of doom: A device to minimize the "swimmer" component in sediment trap collections. *Limnol. Oceanogr.* **35**: 1376-1381.
- Gust, G., A.F. Michaels, R. Johnson, W. G. Dueser, W. Bowles. (1994). Mooring line motions and sediment trap hydrodynamics: *in-situ* intercomparison of three common deployment designs. *Deep-Sea Research.* **41**: 831-857.
- Honjo, S. (1978). Sedimentation of materials in the Sargasso Sea at 5367m deep station. *J. Mar. Res.* **36**: 469-492.
- Hurd, D. C. and Spencer, D. W. (1991). Editors; Marine Particles: Analysis and Characterization. *Geophysical Monograph 63*. AGU. Washington DC. 472p.
- Knauer, G.A., J.H. Martin and K.W. Bruland. (1979). Fluxes of particulate carbon, nitrogen and phosphorus in the upper water column of the northeast Pacific. *Deep-Sea Research* **26A**:97-108.
- Knauer, G. A., Karl, D. M., Martin, J. H. and Hunter, C. N. (1984). In situ effects of selected preservatives on total carbon, nitrogen and metals collected in sediment traps. *J. Mar. Res.* **42**: 445-462.
- Lee, C., Hedges, J. I., Wakeham, S. G. and Zhu, N. (1992). The effectiveness of various treatments in retarding bacterial activity in sediment-trap material and their effects on the collection of swimmers. *Limnol. Oceanogr.* **37**:117-130.
- Michaels, A. F., Silver, M. W., Gowing, M. M. and Knauer, G. A. (1990). Cryptic zooplankton "swimmers" in upper ocean sediment traps. *Deep Sea Res.* **37**: 1285-1296.
- US GOFS Working Group (1989). Sediment Trap Technology and Sampling. Planning Report No. 10. November 1988. WHOI, USA.
- Verardo, D. J., Froelich, P. N. and MacIntyre, A. (1990). Determination of organic carbon and nitrogen in marine sediments using the Carlo Erba NA-1500 Analyser. *Deep Sea Res.* **37**: 157-165.

Figure 6. The surface-tethered sediment trap array.

